

Table of Contents

Introduction	2
What's in the Box?	2
Product Features & Specifications	3
Minimum System Requirements	3
PCI Adapter Card and Break-Out Cable:	4
Quick Guide to Getting Started	5
Hardware Installation	5
Audiophile 2496 Driver & Software Installation	6
Windows 98 Installation	6
Windows 95 Installation	7
Windows NT Installation	8
Macintosh Installation	8
Verifying Windows Driver Installation	10
Verifying Delta Control Panel Installation, PC & Mac	11
Audiophile 2496 System Overview	11
Audiophile 2496 Analog Input/Outputs	11
The Digital Monitor Mixer	12
The Patchbay / Router	12
Synchronization	12
Using the Audiophile 2496 with your Software Application	13
Audiophile 2496 Control Panel Software	16
Monitor Mixer Page	17
Patchbay/Router Page	19
Hardware Settings Page	21
S/PDIF Page	24
About Page	26
Save, Delete, Load Buttons; H/W Installed	26
Audiophile 2496 Recording Tutorial	27
Typical Setup	27
Transferring from DAT to Audiophile 2496	28
Transferring from Audiophile 2496 to DAT, monitoring with DAT ..	29
Audiophile 2496 MIDI Setup	30
Troubleshooting Tips for Frequently Asked Questions	31
Appendix A - Technical Specs	33
Limited Lifetime Warranty	34

Introduction

Congratulations on your purchase of the Audiophile 2496. The Audiophile 2496 is a part of the “Delta” series of digital recording systems and interfaces, designed and manufactured by M Audio, and therefore benefits from the same solid hardware and software driver technology as the other members of the Delta series.

Even if you are experienced in digital recording, please take the time to read this manual. It will give you valuable information on installing your new card and the supporting software, plus help you to fully understand the function and usability of the Audiophile 2496. Once you’re up and running, you will quickly discover the power and brilliance, both in sound and design, of your new Audiophile 2496.

What’s in the Box?

Your Audiophile 2496 box contains:

- This instruction manual.
- One Audiophile 2496 PCI adapter card.
- One Audiophile 2496 break-out cable for S/PDIF and MIDI connections.
- CD or diskette containing software drivers and Delta Control Panel software for Windows 98/95/NT and Macintosh OS 8.5.1 or higher.
- M Audio Warranty Registration card.

About the Audiophile 2496 Digital Recording Interface with MIDI

The Audiophile 2496 gives you stereo (or dual mono) analog inputs and outputs, plus coaxial S/PDIF digital inputs and outputs for a total of 4 ins/ 4 outs of high quality audio I/O. All audio channels support 24-bit data width and any sampling rate from 8kHz to 96kHz. The Audiophile is compatible with all major software programs running on PC and Macintosh computers. The coaxial digital outputs are Dolby Digital 5.1 surround sound capable, making the Audiophile the perfect “high-end” sound card for digital recording, analog or digital transfers, mixing and mastering, as well as DVD and home theatre applications.

Connect a line-level signal from your instrument, mixer or pre-amp, or use the record outputs of your stereo receiver into the Audiophile’s analog RCA jacks located on the PCI card. Record a digital audio signal from your DAT, MiniDisc, CD, or external A/D converter via the Audiophile’s coaxial S/PDIF input located on the break-out cable. Control all routing and hardware settings with the Audiophile’s comprehensive Delta Control Panel software.

The Audiophile 2496's break-out cable also includes MIDI I/O connectors. Provided are one input and one output for use with external MIDI equipment, such as sound modules and drum machines. The MIDI I/O may also be used to synchronize your computer to external devices via MIDI time code.

Within the Audiophile's PCI chip is a hardware digital mixer. Controlled by the included Delta Control Panel software, it may handle all of your routing needs, give you extra control of all left, right and stereo levels, in addition to control of pans, solos and mutes. The Delta Control Panel also lets you manipulate copy protection and other status bits in the S/PDIF output signal. In addition it allows you to configure the Audiophile's internal clock as a master, or slave it to an incoming S/PDIF sample rate.

Product Features & Specifications

- 4x4, 24-bit/96khz, full-duplex recording interface with MIDI I/O.
- Configured as a PCI adapter card with external break-out cable.
- 2x2 analog I/O accepts common unbalanced audio on RCA jacks.
- Break-out cable supports coaxial S/PDIF digital I/O and 1x1 (16 channel) MIDI operation.
- High analog dynamic range: D/A 104dB, A/D 100.4 dB (both A-weighted).
- All data paths support up to 24bit/96kHz performance, no upgrades necessary.
- Comprehensive digital mixing, routing, and monitoring capabilities with included Delta Control Panel software.
- Hardware sample-accurate sync will allow linking of multiple Audiophile and "Delta" series products.
- Windows 95/98 multi-card drivers with ASIO1 and ASIO2 multi-card, GSIF and EASI drivers included; Windows NT multi-card and Mac OS drivers with ASIO 1&2 also included.

Minimum System Requirements

- Windows 95, 98, NT, 2000 or ME. Mac OS 8.5.1 or higher.
- Pentium II 266MHz for 96kHz operation. Pentium 200 MMX for 48kHz or less.
- 128 MB of PC100 RAM for 96kHz operation. 64MB SDRAM for 48kHz or less.
- Mac G3 or G3 accelerator with 64 MB of RAM, 128 recommended. Some faster Power PCs will perform adequately.
- UDMA EIDE or fast SCSI HDD recommended.

PCI Adapter Card and Break-Out Cable:

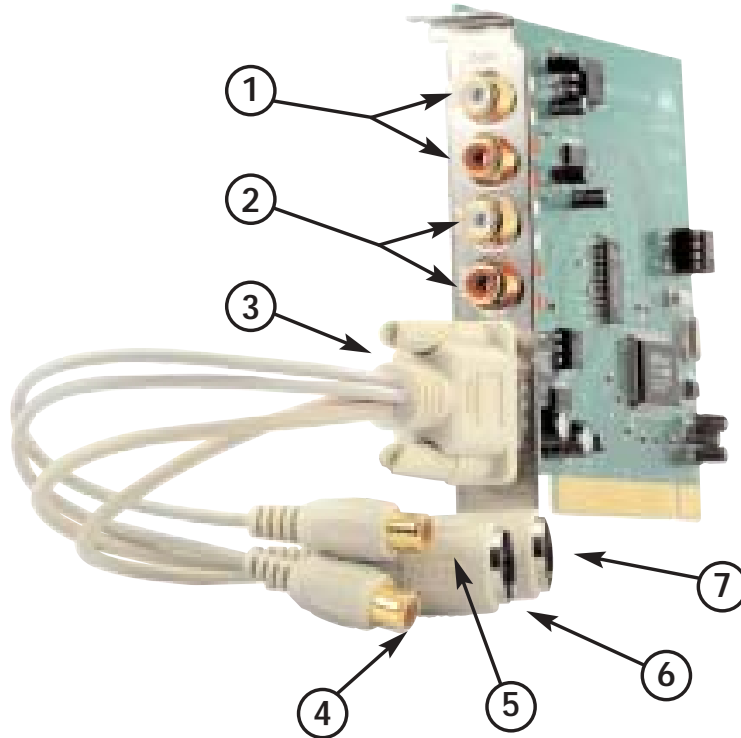

1. Analog INS 1&2: These jacks input analog audio from a variety of external sources. Each jack is female RCA, compatible with common male RCA cables. During stereo operation, the IN1 jack (with white-colored insert) is the left audio channel and IN2 (with red-colored insert) is the right audio channel.
2. Analog OUTS 1&2: These jacks output analog audio to a variety of external sources. Each jack is female RCA, compatible with common male RCA cables. During stereo operation, the OUT1 jack (with white-colored insert) is the left audio channel and OUT2 (with red-colored insert) is the right audio channel.
3. Host Cable connector and Break-Out Cable: This 15-pin D-sub connector accepts the supplied break-out cable to provide S/PDIF and MIDI connectors.
4. Coaxial S/PDIF Input: This RCA connector receives an S/PDIF stereo signal from your coaxial S/PDIF digital source such as a DAT, MiniDisc player or external A/D converter.
5. Coaxial S/PDIF Output: This RCA connector sends an S/PDIF stereo signal to your coaxial S/PDIF digital target device such as a DAT, MiniDisc player or external D/A converter. This output is also used as a Dolby Digital 5.1 (AC3) output for DVD or Home Theatre use.
6. MIDI Input: This 5-pin DIN accepts MIDI data from any external MIDI device, via a standard MIDI cable. Supports up to 16-channels of MIDI data on a single cable.
7. MIDI Output: This 5-pin DIN outputs MIDI data to any external MIDI device, via a standard MIDI cable. Supports up to 16-channels of MIDI data on a single cable.

Quick Guide to Getting Started

Here is what is required to get your Audiophile 2496 up and running:

1. Physically install the Audiophile 2496 card in your computer and connect the provided break-out cable (see 'Hardware Installation').
2. Start Windows and allow Windows' Plug-and-Play to prompt you for the Audiophile 2496 drivers via the Add New Hardware wizard. Install drivers and support software (see 'Windows Software Installation').
3. On the Mac, drag the Delta extension to the Extensions folder, and the appropriate ASIO driver to your application's ASIO folder. Restart. If not using ASIO, set the Sound Manager to Delta (see Mac Installation).
4. Configure your digital recording software to use the Audiophile 2496 as its active audio device (see 'Using the Audiophile 2496 with your Software Application' and also your software application's manual).
5. Hook up your digital and analog audio gear (see 'Audiophile 2496 Recording Tutorials'). Configure your Delta Control Panel software for proper monitoring and playback.

Hardware Installation

To mechanically install the Audiophile 2496, do the following:

1. Turn off your computer.
2. Remove the computer's cover and position the computer so that you may easily access its PCI slots.
3. Select the PCI slot where you will install your Audiophile 2496 PCI host card. Make sure the slot is a PCI slot. If you don't know what "PCI slot" means, check the owner's manual for your computer. PCI slots are distinguishable from ISA slots by being shorter and set back farther from the outside of the computer, however some newer computers have only PCI slots.
4. Before removing the Audiophile 2496 PCI host card from its protective anti-static bag, touch the metal power supply case of the computer in order to dissipate any static electricity your body may have accumulated. You might want to pick up a grounding wrist strap (available from electronics stores like Radio Shack) if you want to be doubly sure you aren't carrying a static charge that could damage the card.
5. Remove the metal bracket that covers the access hole on the back of the computer. This bracket is usually fastened to the computer with a single screw.

6. Position the Audiophile 2496 PCI host card over the target PCI slot and fit the card loosely over it with the card in the upright position. Press the card gently but firmly downward into the slot until the card is completely and squarely seated in the slot. If the card seems difficult to seat, a slight rocking motion may help.
7. Fasten the Audiophile 2496 PCI host card's metal bracket down into the screw hole on the back of your computer using the screw you removed in step 5 above.
8. Place the cover back on your computer.

Now it is time to connect the Audiophile 2496 break-out cable to the PCI card that you have just installed. Never attach the break-out cable with the computer turned on. Doing so could damage the PCI card and/or computer, and void your warranty. Attach the break-out cable to the PCI host card, and secure with the screws that are molded into the break-out cable.

Audiophile 2496 Driver & Software Installation

The Audiophile 2496 system includes a "Software Drivers CD" (or diskette) for Windows 98/95/NT and Macintosh, containing all Windows drivers, Macintosh drivers (including all ASIO drivers), and Delta Control Panel software. Some Audiophiles may come with drivers on floppy disk instead. If so, when following the driver installation procedures outlined below, substitute your computer's floppy drive letter for the CD's drive letter. To install on your system, please follow these steps:

Windows 98 Installation

1. After installing the Audiophile 2496 hardware, boot your system and start Windows. During the Windows boot procedure, the new hardware will be automatically detected by the 'Add New Hardware Wizard', as shown here. Click 'Next>'.



2. The 'Add New Hardware Wizard' will now ask how to locate the driver. "Search for the best driver for your device" is already selected. Click 'Next>'.
3. Windows will give you a selection of locations to search. Make sure that only "Choose a Path" is checked, or click on the check box to do so. Insert the Drivers CD into your CD ROM drive. Type in the drive letter of your CD drive (we will assume here that it is D:\) and the path to the Delta drivers, which will be D:\DeltaSeries\Delta9X. Click 'Next>'.
4. The 'Wizard' reports that its Windows driver file search has found the M Audio Audiophile 2496. Click 'Next>'.
5. Windows is now ready to install the driver files from the specified location. Click 'Next>'. Windows will start to copy the files and show you a progress report screen.
6. The Wizard reports that Windows has finished installing the software. Click 'Finish'. Your Audiophile 2496 is ready for action.

After completion of the driver installation, Windows may require you to restart Windows. If it does request a restart, remove the Drivers CD from the CD drive and respond by clicking "Yes". The system will restart and your Audiophile 2496 is ready for play.

Windows 95 Installation

1. After installation of the Audiophile 2496 hardware, boot your system and start Windows. During the Windows boot procedure, new hardware will be automatically detected.
2. Choose the Install of "driver from disk provided by hardware manufacturer," then click OK.
3. An 'Install From Disk' dialog will prompt you to copy files from the A:\ drive. Insert the Driver software CD into your CD ROM drive. Type in the drive letter of your CD drive (we will assume here that it is D:\) and the path to the Delta drivers, which will be D:\DeltaSeries\Delta9X. Click 'Next>'.
4. Windows will start to copy files, with a progress indicator on the screen. Once this process completes itself, your Audiophile 2496 will be ready for action.

After completion of the driver installation, Windows may require you to restart Windows. If it does request a restart, remove the Drivers CD from the CD drive and respond by clicking "Yes". The system will restart and your Audiophile 2496 is ready for play.

Windows NT Installation

1. Power up your computer after physically installing the Audiophile 2496 card.
2. Go to Start | Settings | Control Panel and double click on 'Multimedia.' Click the 'Devices' tab, then click the 'Add' button.
3. "Unlisted or Updated Driver" will be highlighted at the top of the list. Click OK.
4. The 'Install Driver' box will prompt you to insert the driver disk, and the A: prompt will appear as the path. Insert the Drivers CD into your CD ROM drive. Type in the drive letter of your CD drive (we will assume here that it is D:\) and the path to the Delta drivers, which will be D:\DeltaSeries\Delta_NT. Click OK.
5. The "M Audio Delta Interface Card" driver will appear in the Add Unlisted or Updated Driver dialog box. Click OK.
6. Windows NT will require you to restart your computer for the changes to take effect. Choose "Restart Now." Upon restart, your Audiophile 2496 will be ready for use.

Macintosh Installation

1. Open the System folder on your Macintosh hard drive. In the System folder, locate the Extensions folder.
2. On your Drivers CD disk, open the Delta Products folder, then the Audiophile 2496 folder. Place the extension file "Audiophile 2496 Driver" in your Extensions folder by clicking on it and dragging it to the Extensions folder.
3. If you are using a music program that uses ASIO drivers, it will also have an ASIO folder within the application's folder. In your Mac Delta Drivers folder you will find three Audiophile 2496 ASIO drivers. For Cubase versions 4.x, use the "ASIO2 Delta Audiophile" driver. For Metro, or earlier versions of Cubase, use the "ASIO Delta Audiophile v3" driver. For any music program that is not ASIO2 capable, use the "ASIO Delta Audiophile" driver instead (check your program's documentation). Place the file "ASIO Delta Audiophile" in your program's ASIO folder by clicking on it and dragging it to the ASIO folder.
4. Drag the "DeltaPanel PPC" file onto your Macintosh hard drive. You can run the Delta Control Panel from any place that's convenient, though music software applications that use ASIO will allow you to launch the Delta panel from within the program. If not, we suggest creating an alias to the control panel by highlighting it and pressing Command (Apple key)+M. Then, drag the alias to the desktop.
5. With the Audiophile 2496 PCI card installed, restarting the computer will load the Audiophile 2496 extension. You will be able to visually see the Delta extension icon pass by as your system loads extensions.

6. Go to the Apple menu |Control Panel | Sound. You should see the “built-in” sound icon, plus the Delta icon if your Audiophile 2496 is properly installed. If your music program does use ASIO, leave the Sound Manager driver set to “built-in” for both Sound In and Sound Out. If your program does not use ASIO (check your software’s documentation) and you will be using the Sound Manager to communicate with your Audiophile 2496, set Sound In and Sound Out to “Delta.” See the section “Hardware Settings Page” in the Audiophile 2496 “Control Panel Software” section for information on selecting Sound Manger inputs and outputs. Your Audiophile 2496 is now ready for use.

To configure the Audiophile 2496 for MIDI, you will need to have Opcode’s OMS (Open Music System) installed first. OMS is provided on the CD that came with the unit, or it can be downloaded from the Midiman website’s MIDISPORT drivers page. Opening the OMS 2.3.7 folder and double-clicking on the “Install OMS 2.3.7” program will install OMS in your system. To install the Delta MIDI driver once OMS is properly installed:

1. Open the “Delta Products” folder on the driver CD, then the Delta Audiophile Mac folder. Locate the “Delta Audiophile OMS Driver.”
2. On your Macintosh hard drive, in your System folder, you will find an “OMS Folder.” Drag the Delta Audiophile OMS Driver into the OMS Folder.
3. Restart your computer.

To Configure your Audiophile 2496 MIDI in OMS, go to the Control Panel or Chooser under the Apple Menu, and make sure AppleTalk is turned off (this is recommended, although OMS will sense that it is on and prompt you to turn it off). If you are configuring OMS for the first time, follow these instructions to configure OMS.

1. In the Opcode folder, which you will find on your hard drive, locate the OMS Applications folder, “then OMS Setup.” Double click on OMS Setup.
2. OMS will inform you that it has not yet been configured. Click OK.
3. The Create A New Studio Setup dialog box now appears. Click OK.
4. The “OMS Driver Search” box asks you to choose the port on which you’ve attached the Delta MIDI (either Modem or Printer). DO NOT choose a port, just click “Search.” OMS begins Searching.
5. “OMS Driver Setup” shows the “Delta” MIDI in a list when OMS successfully finds the driver. Click OK. OMS will now define (shows “Identifying”) the Delta output port. The “OMS MIDI Device Setup” dialog box will appear showing the Delta’s output port with a check box to the left of the port, indicating that the port is enabled. Now click on OK.
6. Next, the “My Studio Setup” appears with a ‘file save’ dialog box over it. You will now need to save your new Studio Setup before you can assign an instrument to the Delta’s MIDI output and input. Assign your instrument and you are done. You may now exit OMS Setup by quitting the application.

Verifying Windows Driver Installation

Windows displays the Audiophile 2496 driver status in the Device Manager page of the System Properties dialog box. The Device Manager page is opened via the Windows Start button: select Start | Settings | Control Panel | System | Device Manager. With the Device Manager displayed, click on the '+' next to "Sound, video and game controllers" to open a list of devices, the Audiophile 2496 being a device of that nature. Below is an example view of the Device Manager.

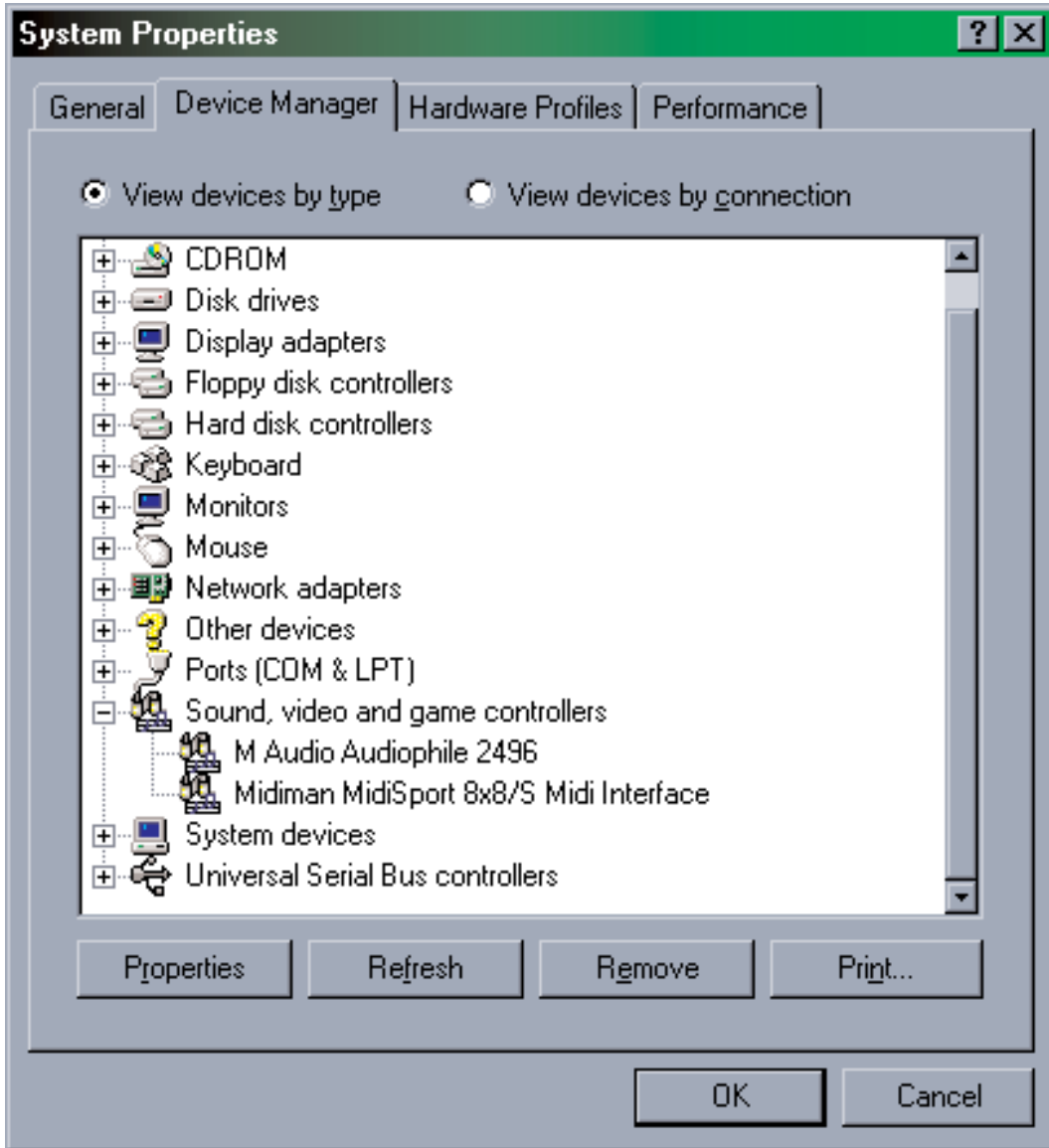

This example shows the M Audio Audiophile 2496 and Midiman Midisport 8x8/S (another product shown here only as an example) entries in the Windows Device Manager device list. The Audiophile 2496 is properly installed with no conflicts, as is the Midisport 8x8/S. If you do not see your M Audio Audiophile 2496 in your Device Manager in this fashion, please jump ahead to the "Troubleshooting" section of this manual.

Verifying Delta Control Panel Installation, PC & Mac

In Windows, open the Windows Control Panel (do so via Start | Settings | Control Panel). If your Audiophile 2496 hardware and Delta Control Panel software are properly installed, the Windows Control Panel should display an “M Audio Delta H/W” icon. By double-clicking on that icon, you may launch the Delta Control Panel software. Also for convenience, you may create a shortcut on your desktop by dragging a copy of the “M Audio Delta H/W” icon from the Control Panel to your Windows desktop using your mouse or trackball. After completing the drag operation, a dialog box will ask you if you wish to create a shortcut — click on ‘Yes’. Once the shortcut is installed, all you have to do is double-click on the shortcut icon on your desktop to launch the Delta Control Panel software.

On the Macintosh, the Delta Control Panel may be placed anywhere on your hard drive, or any partition of your hard drive that you find convenient. Once the control panel file has been dragged from the CD onto your hard drive, you may double click it to launch the Delta Control Panel software. You may create an alias to the control panel by highlighting it, then holding Apple key+M. This alias can then be placed on your desktop.

NOTE: When using a music software program that is ASIO capable, launch the Delta Control Panel software from within that program. Some of the control panel functions will be controlled from within that program, such as master clock setting and sample rate, so it is desirable to launch the music program first, and then the Delta Control Panel from the program’s “launch” or “control panel” button. Without the music program open however, it is okay to open the Delta Control Panel from your desktop or other location.

Audiophile 2496 System Overview

Audiophile 2496 Analog Input/Outputs

The Audiophile 2496 Digital Recording Interface’s analog inputs and outputs are compatible with a variety of audio products. All analog jacks on the Audiophile 2496 PCI card are female RCA. The RCA jacks allow connection to unbalanced (typically consumer or semi-pro) equipment.

NOTE: In order to preserve its high dynamic range and minimize distortion, the Audiophile 2496 does not have microphone pre-amplifiers built into it. Therefore direct connection to a microphone is not recommended. Instead pass the microphone signal through a microphone pre-amp (such as the M Audio DMP2™) and then connect the pre-amp output to the input of the Audiophile 2496.

The Digital Monitor Mixer

The Audiophile 2496 Digital Recording System has a hardware digital audio mixer built into its PCI controller chip. It accepts digital audio streams from all hardware inputs and all outgoing software audio devices, mixes them with 36-bit internal precision and then provides the mixed output to the analog outputs (H/W OUT1/OUT2 as a stereo pair) and/or the S/PDIF outputs. At the same time the mixer may be used for stereo mix-down, with the mixer's output recorded into the user's application software. The digital audio mixer is configured and controlled by the included Delta Control Panel Software.

The Patchbay / Router

In addition to the built-in monitor mixer, the Audiophile 2496 Digital Recording Interface includes an output patchbay/router. The patchbay/router allows each output (analog or digital) to be connected to a variety of input sources. The Audiophile 2496's outputs may accept audio from software sources (the output devices visible in your audio software applications) or from hardware sources such as the analog and digital inputs or the monitor mixer. This capability makes the Audiophile 2496 quite flexible for WAV output, monitoring, or directly connecting inputs to outputs for "system test" purposes.

Synchronization

For proper operation, the entire Audiophile 2496 system is always synchronized to a single master clock. The master clock is chosen via the Delta Control Panel software and this clock may be derived from either the Audiophile 2496's internal crystal oscillators or from S/PDIF In. Most of the time the master clock is taken from the internal crystal oscillators. However, the S/PDIF option must be used in situations where the Audiophile 2496 is monitoring or recording from the S/PDIF input port.

As stated, most of the time the master clock is derived from the internal crystal oscillators. Operation in this mode is similar to that of a generic sound card and should be used whenever the S/PDIF In is not being used. In this mode, the audio software application selects one of the supported Audiophile sample rates and starts playback and/or recording. The Audiophile 2496 hardware then achieves this sample rate by activating one of its internal crystal oscillators and dividing the rate of that oscillator by some integer value.

In situations where S/PDIF In is being used (either to record or just monitor), the Audiophile 2496 should be configured to get its master clock from the S/PDIF In data stream. Without this setting, S/PDIF input will not function. Setting the Audiophile to derive its master clock from the incoming S/PDIF stream keeps the Audiophile in tight synchronization with that external S/PDIF device, and no drift occurs. Digital transfers are therefore precise and bit-accurate.

For advanced users, the S/PDIF In option may be used to operate the Audiophile 2496 at non-standard sample rates. When the Audiophile is set to derive its master clock from S/PDIF In, the Audiophile's sample rate will automatically match that of the incoming S/PDIF data stream. Therefore, sample rates anywhere between 22kHz and 100kHz are possible.

NOTE: When the S/PDIF In is selected as the master clock source, the Delta Audiophile 2496 mixer's frequency response will be affected by whatever sample rates you inject at the S/PDIF In. This is because (1) the digital mixer operates at the same sample rate as the rest of the board, and (2) sample rate and frequency response are directly correlated.

Using the Audiophile 2496 with your Software Application

Once the Audiophile 2496 hardware and software drivers are properly installed, the Audiophile is ready for use with your music application software. Some software applications may require you to highlight or enable the Audiophile 2496 drivers within the program in order to use the Audiophile, while others may have a utility that analyzes or profiles the audio cards in your system and enables the drivers. Your software should have an audio device driver setup page and if you have problems locating it you should consult your software's documentation.

WINDOWS MME AUDIO INPUT DEVICES: All Audiophile 2496 analog and S/PDIF inputs may be used simultaneously for a total of 4 input channels. Within your software application(s), the names of the Audiophile 2496 audio input devices are:

PCM In 1/2 Delta-AP
S/PDIF In Delta-AP
Mon.Mixer Delta-AP

“AP” in these names stands for “Audiophile.” The PCM In device allows recording a stereo stream directly from the analog input pair. The S/PDIF In device allows you to record a stereo stream directly from the S/PDIF input. The Mon.Mixer device allows stereo recording from the digital “monitor” mixer built-into the Audiophile. The audio data recorded from this device is the mix of input and output streams set up in the Delta Control Panel software's Monitor Mixer (see ‘Audiophile 2496 Control Panel Software’ section).

Note that all of the input devices are stereo. Your application software may break these down further to “left” and “right” mono devices. Therefore you may see them as “Left PCM In 1/2 Delta-AP, Right PCM In 1/2 Delta-AP”, “Left S/PDIF In Delta-AP, Right S/PDIF In Delta-AP”, or “Left Mon. Mixer Delta-AP, Right Mon. Mixer Delta-AP,” etc. from within your recording software.

WINDOWS MME AUDIO OUTPUT DEVICES: All Audiophile 2496 analog and S/PDIF outputs may be used simultaneously for a total of 4 output channels. Within your software application(s), the names of the Audiophile 2496 audio output devices are:

WavOut 1/2 Delta-AP
WavOut S/PDIF Delta-AP

“AP” in these names stands for “Audiophile.” WavOut devices allow playing a stereo audio stream to the analog hardware outputs (for WavOut 1/2), the S/PDIF hardware output (for WavOut S/PDIF), or into the hardware router or mixer. Your application software may break each of these stereo devices down further to “left” and “right” mono devices. Therefore you may see them as “Left WavOut 1/2 Delta-AP, Right WavOut 1/2 Delta-AP”, or “Left WavOut S/PDIF Delta-AP, Right WavOut S/PDIF Delta-AP”, from within your music software. Most software will handle the outputs as stereo pairs but allow you to pan audio left or right within the pair. Therefore to send a mono output to OUT1 (for example), choose “WavOut 1/2 Delta-AP” and pan that track hard left.

Note that each device name begins with “WavOut.” This is to remind you that these are software devices, and not always connected directly to output hardware. Instead they are connected to the Audiophile 2496’s internal patchbay/router and may be sent to one of several destinations. For more on the patchbay/router, see the Patchbay/Router section of the Delta Control Panel software discussion.

MACINTOSH SOUND MANAGER INPUTS AND OUTPUTS: The Apple Sound Manager limits the user to one stereo pair for input and one stereo pair for output. Within your music software, the device selection when using the Sound Manager drivers for input and output will be “Sound Manager” both for input source and for output port.

To select the Sound Manager driver, open the Apple Menu and go to Control Panel | Sound. For both “Sound In” and “Sound Out,” click and highlight the Delta icon, then exit. You may select which Delta hardware stereo input pair and stereo output pair will be used for the Sound Manager’s Sound In and Sound Out in the Delta Control Panel “Hardware Settings Page” (see section, “Hardware Settings Page” under “Delta Control Panel”). Whichever stereo pair you select, the software input and output device selection within your music program will remain the same, i.e., “Sound Manager” will be the proper selection.

ASIO DRIVER INPUT DEVICES: When using the ASIO audio drivers with programs that support ASIO-style audio, the input devices are displayed as mono devices. Within ASIO software applications, the names of the Delta Audiophile 2496 audio input devices are:

Delta-AP1
Delta-AP2
Delta-AP S/PDIF L
Delta-AP S/PDIF R
Delta-AP Mon.Mixer L
Delta-AP Mon.Mixer R

Notice the S/PDIF In and Monitor Mixer names include “L” and “R” characters. “L” indicates the left channel of the stereo stream, while “R” indicates right channel.

ASIO DRIVER OUTPUT DEVICES: The Audiophile 2496’s ASIO output devices appear in stereo pairs. Because each device is stereo, you may see “left” and “right” references within your software application. This allows the application to pan audio left and right under software control. To send a signal to a Delta ASIO output 1 (for example) as a mono output send, one would choose “Analog 1/2 Delta-Audiophile 2496” for that track’s output port, and then pan that output hard left. The ASIO outputs are named as follows:

WavOut 1/2 Delta-AP
S/PDIF L/R Delta-AP

WINDOWS MULTIMEDIA SETTINGS: Windows may be set up to use the Audiophile as its default audio device, allowing system sounds to be played through the Audiophile. This also enables you to use the Audiophile with the sound applets included with Windows. To set this up, go to Control Panel | Multimedia. In the Audio Properties page, set the Playback and Recording devices to the Audiophile 2496 input and output devices of your choice.

MIDI DRIVERS: The Audiophile 2496 MIDI drivers, once enabled in your software’s MIDI Setup, will appear as a MIDI source and a MIDI port within that program’s track configuration windows. The MIDI input driver is named “MIDI In Delta-AP”, and the MIDI output driver is named “MIDI Out Delta-AP”. Some software applications allow you to redefine/rename these devices per supplied or manually entered instrument definitions.

Windows may also use the Audiophile 2496 as its default MIDI device. This allows the Audiophile 2496 to be used with the MIDI applications included with Windows. To set this up, go to Control Panel | Multimedia | MIDI. Set the Audiophile MIDI driver as the default Windows MIDI driver by clicking on the “MIDI Out Delta-AP” entry in the driver list, then selecting “OK” or “Apply”.

Audiophile 2496 Control Panel Software

ON THE PC: Once the Audiophile 2496 is properly installed, an “M Audio Delta H/W” icon will be displayed in your Windows Control Panel. By double-clicking on that icon, you will launch the Delta Control Panel software. You may also launch the Delta Control Panel software from the desktop if you have previously created a shortcut there (see “Verifying Delta Control Panel Software Installation” section for instructions on how to do this). Once the Delta Control Panel software has been opened, you will see the main panel and its several tabs. To display a desired page, click on its tab. Below are functional descriptions of each page.

ON THE MAC: The Delta Control Panel must be placed on the hard drive by dragging the application from the Drivers CD. Once this is done, an alias may be created by highlighting the Delta Control Panel on the hard drive and pressing the Apple key+M. Then, this alias may be dragged to the desktop. Double clicking either will launch the control panel. Once the Delta Control Panel software has been opened, you will see the main panel and its several tabs. To display a desired page, click on its tab. Below are functional descriptions of each page. Though most of the descriptions are Windows based, the functions are identical unless otherwise indicated. Within each section you will find the necessary name changes for using the Delta Control Panel “ON THE MAC.”

NOTE: When using a music software program that is ASIO capable, launch the Delta Control Panel software from within that program. There will be a button in the ASIO or Audio setup page that will allow you to do so. Some of the control panel functions will be controlled from within that program, such as master clock setting and sample rate, so it is desirable to launch the music program first, and then the Delta Control Panel from the program’s “launch” or “control panel” button. Without the music program open however, it is okay to open the Delta Control Panel from your desktop or other location.

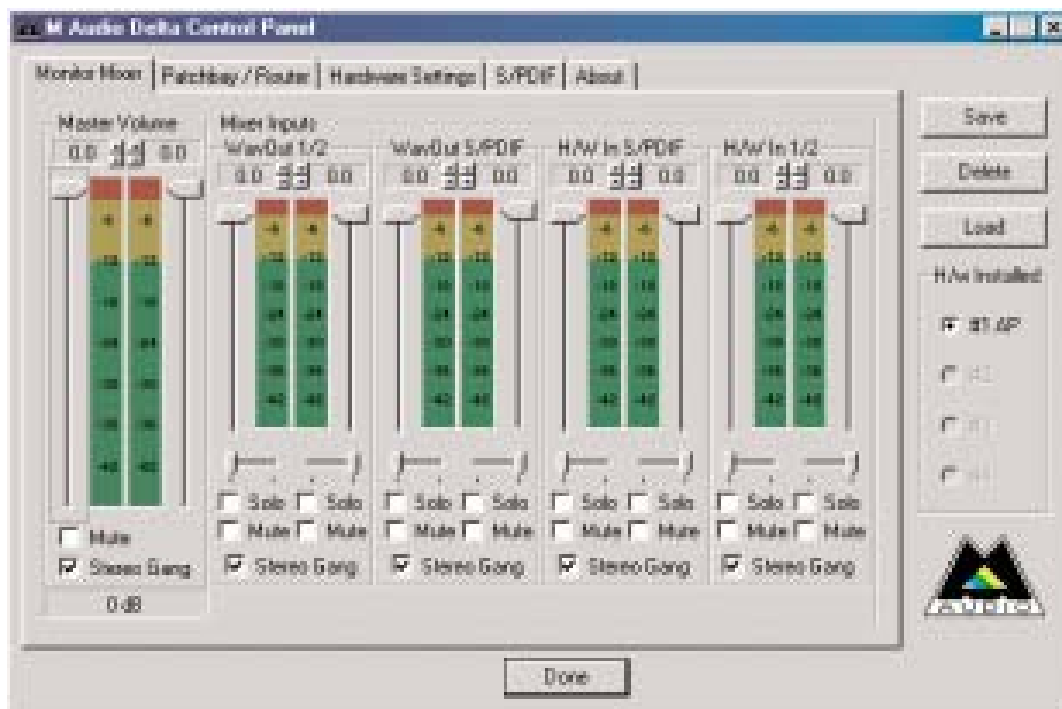

Monitor Mixer Page

The Monitor Mixer is the first page that appears when the Delta Control Panel is opened, and controls the digital mixer built into the Audiophile 2496's PCI controller chip. As described in previous sections, the output of this mixer may be assigned to the OUT1/OUT2 analog outputs and/or the S/PDIF Out digital output. At the same time, the mixer outputs may be recorded in stereo by software.

The Monitor Mixer Page is essentially a collection of volume level faders, audio level (or 'peak') meters, and solo/mute controls. For each mixer output and input channel there is one of each: a volume fader, a peak meter, a solo control, and a mute control.

LEVEL FADERS: Each volume fader may be controlled by dragging its fader 'handle' vertically with the mouse, or by clicking on the 'handle' to make it active and then adjusting it with the up/down cursor keys of your computer keyboard. Because the mixer has no gain, these faders only attenuate (reduce) the signal levels. The highest setting is 0dB, or 'Unity Gain.' The default fader setting is the quietest setting, -144dB, which essentially mutes the audio. A pair of level faders may be "ganged" so that both channels may be adjusted together as a stereo pair.

Also, at the top of each fader and meter is a fader level "fine adjustment" control. Clicking on the small "up" and "down" arrows will adjust the corresponding fader setting in 0.5dB increments. Next to each fine adjustment control is a numerical fader readout that is always current and active.

PEAK METERS: Each peak meter indicates an audio signal level in “dB relative to full-scale.” This means that a full-scale signal is referred to as “0 dB” and a signal that is 12dB ‘quieter’ than full-scale is referred to as “-12dB.” The meters are vertically color-coded into three sections: green, yellow and red. The green section represents a safe zone, ranging from approximately -48dB to -12dB. Most audio signals should appropriately fill this section of the meter. The yellow section ranges from -12dB to -3dB as the signal approaches a ‘hotter’ level. For best capture resolution, recording in this area is both safe and advised. The red section of the meter ranges from -3dB to 0dB. On the input level meters, a 0dB condition indicates overload and audio clipping may occur. Therefore be careful to adjust the incoming audio levels so that they do not peak in the red section too long (you might use the monitoring capability of the Audiophile 2496 to let your ears be the judge). Please note that the S/PDIF inputs are actually digital data and can not clip or distort the Audiophile S/PDIF input in any manner – in other words, the “red zone” of the peak meter is perfectly safe for digital inputs.

On all output level meters, 0dB indicates full-scale output. Unlike the inputs, hardware clipping is impossible on the outputs because of the 36-bit resolution built into the mixer hardware. However, please note that it is possible to mix multiple tracks within your software application and cause clipping to occur in the output stream before it reaches the Audiophile output hardware or monitor mixer.

MASTER VOLUME: At the left side of the Monitor Mixer page, you will see the ‘Master Volume’ faders and peak meters. These faders have the longest ‘throw’ and highest meter resolution of any level controls in the mixer page. They control the overall stereo level of the mixer output. The peak meters indicate the output signal levels with respect to full-scale and are directly affected by the settings of the master volume faders.

MIXER INPUTS: The ‘Mixer Inputs’ are inputs to the monitor mixer. These inputs accept hardware audio streams (directly from the Audiophile’s analog and digital input ports) and software audio streams (digital audio generated in software to be output). This combination of streams makes the monitor mixer extremely flexible. Each mixer input channel has its own level fader and may be panned anywhere in the left/right stereo field. Each input also has its own peak meter. The peak meters indicate the incoming “pre-fader” levels of the incoming audio and are therefore not affected by the fader settings. However, the input faders do affect the levels of the signals exiting the mixer and you will see the effect of the input faders on the output “Master Volume” peak meters.

From left to right, the inputs to the mixer are labeled “WavOut 1/2”, “WavOut S/PDIF”, “H/W In S/PDIF” and “H/W In 1/2”. The first two inputs accept the digital audio streams being sent from your software application (or Windows) to the driver devices with those same names. Each name begins with “WavOut” to remind you that these are software streams and may not necessarily be routed to any physical outputs (see Patchbay/Router Page). The rightmost two channels are audio streams

from the physical Audiophile 2496 hardware inputs, hence the “H/W” at the front of each name. On the Mac, these inputs are labeled “SM/ASIO”, as these software streams will be receiving their digital audio either from the Sound Manager or the ASIO driver, depending on your selection.

PAN: Each mixer input may be individually panned anywhere in the stereo output mix. A pan control is positioned directly under each input channel peak meter and has the appearance of a small vertical pointer. To make a coarse adjustment, click on the pan control with your mouse and drag it to the desired position. For finer adjustment (in 1% increments), you may click on the pan control to make it active, and then use the left/right or up/down cursor keys on your computer keyboard. Either way, while the pan setting is being adjusted, its value will appear numerically in the Master Volume’s status box (below the Master Volume Stereo Gang control) as a percentage from left pan to right pan: -100% represents far left, +100% represents far right, and 0% represents the center.

SOLO: Each mixer input channel has a “Solo” checkbox associated with it. Clicking on and activating a Solo box will solo the selected channel by essentially muting all other signals. When more than one channel has Solo selected, all solo channels will be summed to the solo ‘buss’ (path), which is what one might consider an ‘in place’ solo as opposed to a PFL, or pre-fader listen (levels and pans still apply). Deactivating all solo boxes will return all input channels to their previous mute/unmute states.

MUTE: Every mixer input channel has a “Mute” checkbox associated with it. Clicking on and activating the Mute box will remove that signal from the stereo buss. Deactivating the Mute box will add the signal back into the stereo buss.

STEREO GANG: All input channel pairs have a “Stereo Gang” capability. Clicking on and activating the Stereo Gang checkbox will link (or “gang”) the left/right faders so that both channels may be adjusted together as a stereo pair.

Patchbay/Router Page

The Patchbay/Router page allows you to connect each of the Audiophile’s hardware outputs (a pair of analog outputs and a pair of digital output channels) to specific audio sources within the Audiophile 2496 board. To display this page, click the “Patchbay/Router” tab of the Delta Control Panel.

ON THE MAC: Please substitute the name “SM/ASIO” where references are made to “WavOut.” SM/ASIO are the software outputs on the Mac, while WavOut are the software outputs on the PC. Substitute “Windows multimedia applet” with “Sound Manager Applet.”

The leftmost vertical column of Patchbay/Router page, “H/W Out 1/2,” connects this

hardware analog stereo pair to one of five stereo sources:

1. The default setting, “WavOut 1/2”, connects ports OUT1 and OUT2 to your music software or Windows multimedia applet. In other words, when music software plays audio to the device named “WavOut 1/2 Delta-AP” it will be routed directly to the Audiophile hardware analog output jacks.
2. The second option, “Monitor Mixer,” connects ports OUT1 and OUT2 to the outputs of the Audiophile 2496 monitor mixer. For more information of the capabilities of the monitor mixer, please see the section “Monitor Mixer Page.”

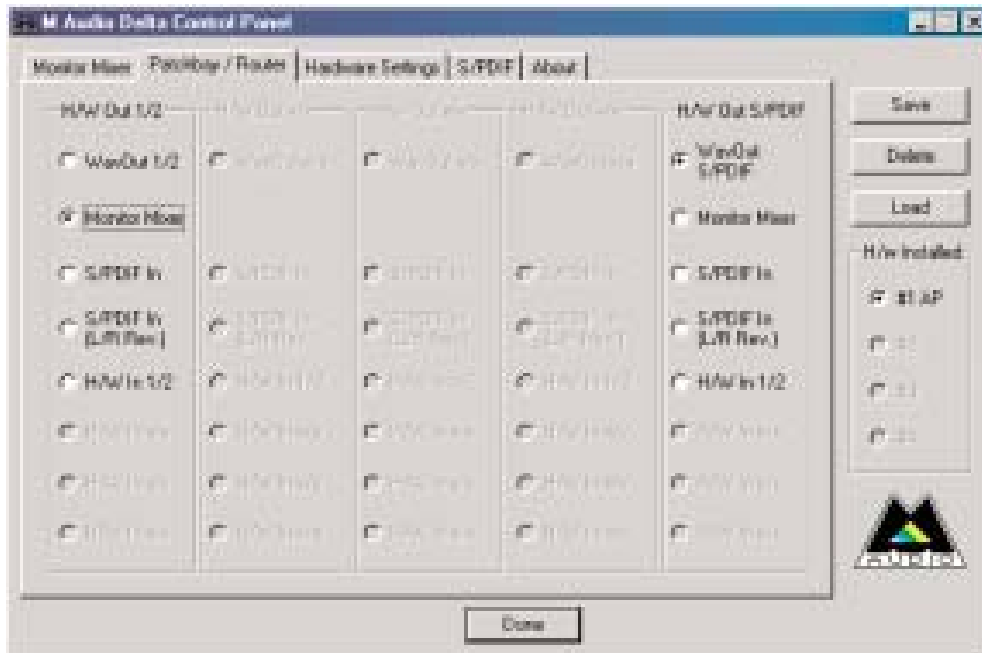

3. The third option, “S/PDIF In,” connects ports OUT1 and OUT2 directly to the hardware S/PDIF input of the Audiophile card. The left channel of the S/PDIF In is routed to OUT1 and the right channel of the S/PDIF In is routed to OUT2.
4. The fourth option, “S/PDIF In (L/R Rev.),” functions identically to the third option, except that the left and right channels are swapped. Therefore in this mode, the left channel of the S/PDIF In is routed to OUT2 and the right channel of the S/PDIF In is routed to OUT1. Note that this option is solely for monitoring/mixing purposes — the S/PDIF In will not record in reverse when this option is checked.
5. Selection five connects the Audiophile hardware analog inputs 1 & 2 directly to the Audiophile’s hardware analog outputs 1 & 2. For example, if “H/W In 1/2” were selected, any signal present at the IN1 port will be copied to OUT1, and any signal present at the IN2 port will be copied to OUT2.

The next vertical column of Patchbay/Router page, “H/W Out S/PDIF,” connects the Audiophile’s hardware S/PDIF output to one of five stereo sources:

1. The default setting, “WavOut S/PDIF,” connects the S/PDIF Out port to your music software or Windows multimedia applet. In other words, when music software plays audio to the device named “WavOut S/PDIF Delta-AP” it will be routed directly to the hardware S/PDIF output port on your Audiophile card.
2. The second option, “Monitor Mixer,” connects the S/PDIF Out port to the output of the Audiophile 2496 monitor mixer. For more information on the capabilities of the monitor mixer, please see the section “Monitor Mixer Page.”
3. The third option, “S/PDIF In,” connects the S/PDIF Out port directly to the S/PDIF In port of the Audiophile card. The left channel of the S/PDIF In is routed to the left channel of S/PDIF Out and the right channel of the S/PDIF In is routed to the right channel of S/PDIF Out.
4. The fourth option, “S/PDIF In (L/R Rev.),” functions identically to the third option, except that the left and right channels are swapped. Therefore in this mode, the left channel of the S/PDIF In is routed to the right channel of S/PDIF Out and the right channel of the S/PDIF In is routed to the left channel of S/PDIF Out. Note that this option is solely for monitoring/mixing purposes — the S/PDIF In will not record in reverse when this option is checked.
5. Selection five connects the hardware analog inputs 1 & 2 directly to the Audiophile’s S/PDIF Out port. Any signal present at the IN1 port will be sent to the left channel of the S/PDIF Out, and any signal present at the IN2 port will be sent to the right channel of the S/PDIF Out.

At this point, you may begin to realize the versatility of the Monitor Mixer and the Patchbay/Router, and the relationship between the two. You may want to re-read this section and make some practice adjustments within the Delta Control Panel software to become proficient in routing and mixing. If somewhere in the process you become confused, you may always restore the default settings to use the Audiophile as a standard 4-in 4-out sound card — just choose the topmost option in each of the Patchbay/Router columns.

Hardware Settings Page

The Hardware Settings page of the Delta Control Panel gives you control over miscellaneous features of the Audiophile 2496. To display this page, click the “Hardware Settings” tab of the Delta Control Panel.

MASTER CLOCK: This section allows you to select the source of the board’s master clock: Internal Xtal (‘Xtal’ is an abbreviation for ‘crystal’) or S/PDIF In. Master clock operation is outlined in the Synchronization section of this manual. Internal Xtal is the default setting. Be sure to select “S/PDIF In” if you will be recording or monitoring an

S/PDIF In stream.

NOTE: If “S/PDIF In” is selected as the master clock source, be sure to supply a valid S/PDIF signal to the board’s active S/PDIF input. Otherwise, erratic timing and/or improper sample rates will be experienced.

Once a master clock source has been selected, its synchronization status is continually monitored and displayed below the master clock radio buttons. If internal crystal is selected, the status display will always say “Locked.” On the other hand, if S/PDIF In is selected as the master clock source, the control panel will display “Locked” only when a valid S/PDIF signal is detected. It will display “Unlocked” when there is no signal at the S/PDIF input, or when the signal is corrupt or invalid for any reason.

CODEC SAMPLE RATE: This section indicates the Audiophile’s current sample rate. The digital mixer, converters and digital ports are all locked to this sample rate. If the Audiophile is currently in use by some software application, then this indicated sample rate was set by the software application. Otherwise, this is the “idle” sample rate that the Audiophile is using when not in use by software applications. The idle sample rate is controlled by the “Reset Rate When Idle” checkbox on the Delta Panel. When “Reset Rate When Idle” is not checked, the Audiophile simply retains the last sample rate set by an application when the application discontinues use of the Audiophile. When it is checked, the Audiophile will switch (if necessary) to the selected sample rate whenever the Audiophile is not in use by an application.

NOTE: Because the digital monitor mixer runs at the sample rate of the rest of the board, and because sample rate directly affects frequency response, it may sometimes be desirable to keep the sample rate at or above 44.1 kHz while using the monitor mixer. This is accomplished by enabling “Reset Rate When Idle” and selecting a sample rate of 44.1 kHz or greater.

The Delta Panel also allows you to lock the Audiophile sample rate to some specific value, and only that value. This is accomplished by checking the “Rate Locked” checkbox. When you lock the Audiophile sample rate, this will disallow any application from setting the sample rate differently. If an application attempts to do so, you will most likely see an error message. The default setting is to leave “Rate Locked” unchecked.

S/PDIF SAMPLE RATE: When using S/PDIF In as your master clock, this section tells the driver what the expected S/PDIF input sample rate is. The section is only displayed when the board is set to use S/PDIF In as the master clock source. From the list, select the sample rate closest to that of the S/PDIF input data. The sample rate selected here will be the only sample rate available to the software applications. Therefore, you must set your audio software application to this same sample rate or else the application will display an error message.

NOTE: When S/PDIF In is the master clock source, the digital monitor mixer will run at the sample rate received at the S/PDIF In. Since frequency response and sample rate are directly related, the mixer frequency response will be directly related to the sample rate of the S/PDIF input data.

MULTITRACK DRIVER DEVICES: The Audiophile 2496 drivers may intelligently synchronize the beginning of recording and playback across all audio devices on the board. When using application software that is capable of using multiple channels simultaneously, select “Single and In-Sync” to ensure that all audio channels will begin playback and/or recording at the same time. Otherwise select “Independent” to allow the audio channels to play independently — this setting may be desirable if more than one application needs to access the Audiophile 2496 simultaneously. A third option appears when more than one Delta series card is installed in the machine. The “Multiple Card Sync” selection may be made when you want all channels across all installed Delta cards to begin playback and/or recording at the same time.

DMA BUFFER SIZES: This section specifies the amount of system memory dedicated to digital audio buffering. Setting a buffer size that is too small may result in clicks or pops in the audio stream as some data may be lost. Larger buffers cause slightly more latency but prevent the pops and clicks that might occur with smaller buffer sizes — the default settings are recommended but you may desire to tweak these default settings to suit your tastes.

ON THE MAC: The Hardware Settings Page in the Macintosh version of the Delta Control Panel also contains software switches that allow you to select which Delta input and output stereo pair will be used by the Sound Manager, if and when you choose the Delta as the Sound Manager input and output device. If you go to the Apple menu | Control Panel | Sound and highlight the Delta icon for Sound In and Sound Out, then your Apple system sounds will be routed to the Audiophile hardware output that you have selected here, and Alert Sounds, if you choose to record, will receive their input from the Audiophile hardware input that you select here.

You will want to choose the Audiophile for input and output in the Sound control panel if your music program does not use ASIO and the Delta ASIO drivers. If you are using the ASIO drivers (see Mac Software Installation), then leave the Sound control panel selection to “built-in.” With the Sound control panel set to built-in, these Sound Manager settings in the Delta Control Panel will have no effect.

The Sound Manager driver limits you to using only one of the Audiophile 2496 stereo input pairs for audio input and only one of the stereo output pairs for output. These do not need to be matched pairs- you can use inputs 1&2 for Sound In and S/PDIF for Sound Out, for example, or any combination that you choose. The following screen shot shows the Hardware Settings page on the Mac with the Sound Manager I/O set to “Analog 1&2” for Input and “Analog 1&2” for Output. Once you have made a

selection, go to the File menu and “Save as Preferences.”

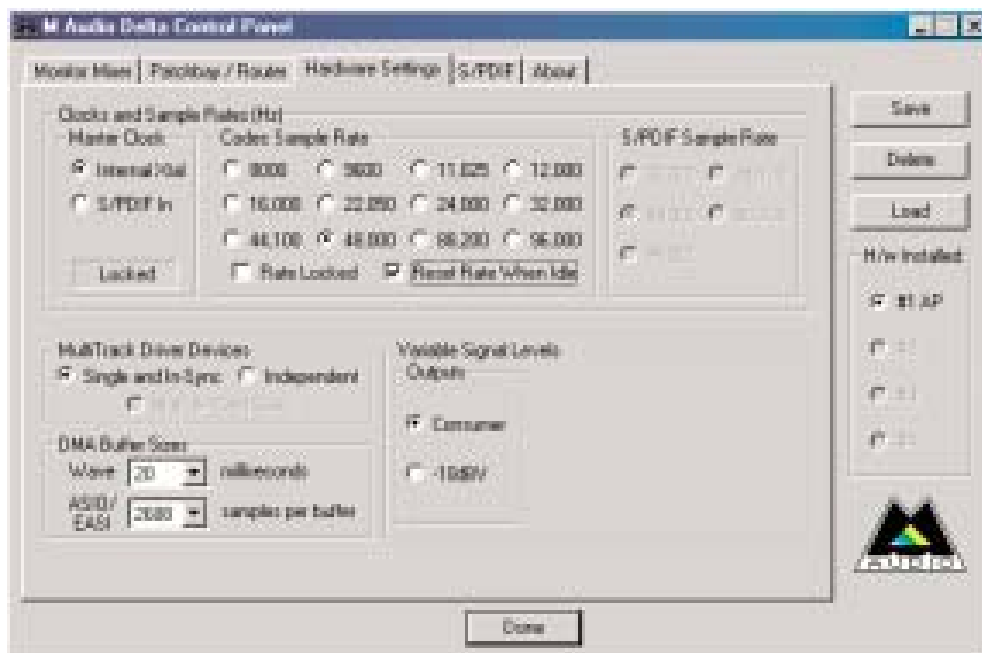

VARIABLE SIGNAL LEVELS: The options in this section allow the user to match the Audiophile analog output levels to the operating signal levels of external audio equipment. Two level selections are available: ‘Consumer’ and ‘-10dBV’. The ‘Consumer’ setting is the least sensitive of the two settings, and ‘-10dBV’ the most sensitive. The ‘Consumer’ setting therefore has the most headroom and can accept the hottest signals. ‘-10dBV’ should be chosen if you feel (or hear) ‘Consumer’ levels clipping or distorting your externally connected equipment.

NOTE: The analog inputs of the Audiophile are fixed to ‘Consumer’ levels. If you want to maintain equal analog signal levels in and out of the Audiophile (also known as “unity gain”), you should select consumer output levels to match the consumer input levels.

S/PDIF Page

The S/PDIF page of the Delta Control Panel configures the S/PDIF output format and displays the status of the S/PDIF input. To display this page, click the “S/PDIF” tab of the Delta Control Panel software.

DIGITAL INPUT: This group box displays the current S/PDIF input status. The Audiophile’s S/PDIF receiver is capable of recognizing a valid input signal versus an invalid, corrupt or non-present one. When a valid signal is detected at S/PDIF In, this group box displays “Valid Input Detected.” When an invalid signal is detected or no signal is present, the group box displays “Invalid or Not Present.” Below this message are two ‘grayed-out’ buttons: “Coax (RCA)” and “Optical.” These are functions of the Delta DiO 2496, another product in the M Audio “Delta” series, one

with both optical and coaxial S/PDIF inputs. These controls do not apply to the Audiophile 2496.

DIGITAL OUTPUT FORMAT: Within the “Digital Output Format” group, you choose the digital audio format of the S/PDIF output. The default setting, “Consumer,” is a true S/PDIF format and is recognized by all consumer devices. The alternate “Professional” setting is an AES/EBU type data stream, but electrically is S/PDIF. This can be used as an AES/EBU work-around that is recognized by some but not all AES/EBU devices.

For both consumer and professional output formats, the “Advanced” checkbox will allow you to force a few particular status bits in the outgoing S/PDIF signal. The advanced option is for expert users only; however, if you find yourself in configuration trouble, you can always select the “Restore Defaults” button to restore the outgoing status bits to their factory settings. When “Consumer” and “Advanced” are both selected, the group “Consumer Format Advanced Settings” will appear. When “Professional” and “Advanced” are both selected, the group “Professional Format Advanced Settings” will appear. These groups are described below:

Consumer Format Advanced Settings (Copy Mode): Copy protection, also known as Serial Copy Management System (SCMS), is written into the S/PDIF status block, a reserved part of the S/PDIF digital stream that is independent of the actual audio data being transmitted. It can be used to inhibit the amount of copies that can be made, or allow for unlimited copying. Three SCMS modes are available. “Original (Copy Permitted)” indicates that the source material may be copied by a receiving device. “1st Generation” indicates that the source material is a first generation or later copy. Most devices that are capable of recording will reject material with this SCMS mode set. The final option is “No SCMS” which may be used to override the other two modes and allow a recording device to successfully record the audio data. Different manufacturers’ products may interpret these codes differently and require you to set these bits by “trial-and-error” until proper operation is achieved.

Consumer Format Advanced Settings (Emphasis): This status bit is used to indicate if pre-emphasis has been applied to the outgoing digital audio signal. The default is “None” and rarely will any user want to set the value to “50/15uSec” unless the transmitted audio has been encoded with 50/15uSec pre-emphasis.

Consumer Format Advanced Settings (Data Type): The user may assign the outgoing data as audio or non-audio data. The default is “Audio.” When sending AC-3 (“Dolby Digital” 5.1 surround sound) via the Audiophile S/PDIF OUT port to an external decoder, you should set the Data Type to “Non-Audio.” Most AC-3 surround sound decoders expect this setting and will reject the information if the Data Type is set to “Audio.”

Professional Format Advanced Settings (Data Type): The user may assign the outgoing data as audio or non-audio data. The default is “Audio.” It is possible to send AC-3 type signals out in the professional mode, although it is not usually done this way. If

you for some reason must send AC-3 in professional mode, be sure to set the Data Type to “Non-Audio” for the same reasons outlined in the above paragraph.

Professional Format Advanced Settings (Emphasis): The user may choose to indicate or not indicate if pre-emphasis has been applied to the outgoing digital audio signal. The default is “None” and rarely will any user want to set the value to “CCITT” or “50/15uSec” unless the transmitted audio has been encoded with one of those types of pre-emphasis.

About Page

The “About” page, while displaying the handsome M Audio logo and applicable copyright information, also reports the driver version and control panel software version. If you have Internet browsing capabilities and are currently connected to the Internet, clicking on the Midiman copyright will link you to the M Audio / Midiman web site (PC only).

Save, Delete, Load Buttons; H/W Installed

ON THE PC, at the rightmost side of the Delta Control Panel are the Save, Load and Delete buttons as well as an “installed hardware” set of radio buttons. These controls appear regardless of what Delta Control Panel page is being displayed.

SAVE, DELETE, LOAD: The Delta Control Panel always retains the last settings entered. However the Save, Delete, and Load functions expand this capability to store different sets of control panel settings using different configuration names. These configurations are then available for recall at a later date and time.

Clicking the ‘Save’ button brings up a dialog box prompting you to name the current configuration. Once you have done this, click ‘OK’, and your current configuration has been saved to disk. If you decide that you no longer need a particular configuration, click the ‘Delete’ button. Highlight the name of the configuration file that you wish to delete, and click the ‘OK’ button. To recall or reload a saved configuration, click the ‘Load’ button. Highlight the name of the configuration that you wish to recall, and click ‘OK’. Those settings will now appear in the Delta Control Panel and the driver will automatically update the hardware.

H/W INSTALLED: Up to four Delta series cards may be installed in a PC system simultaneously (Note: On the Drivers CD, see the “Multi-card Installation” readme file). This section displays all installed Delta cards including the Audiophile, and allows you to select which particular card is under the control of the control panel software. To select a card for configuration, click the radio button to the left of that particular card in the “H/W Installed” list. Because of a space restriction, the Audiophile appears abbreviated as “AP” in this list.

ON THE MAC: To save your Delta Control Panel settings, go to the File menu and select

“Save,” or “Save as.” A dialog box will appear, prompting you to name the current configuration. Once you have done so, click the Save button. To save the current settings as your default, go to the File menu and choose “Save as Preferences.”

In the upper right-hand corner of the control panel is a “H/W Installed” drop-down list. At the time of this writing, the Delta Mac ASIO drivers will support only a single Delta device, and of course the Sound Manager will support only one stereo pair regardless of how many audio cards are installed in your system. The H/W Installed list will display “Audiophile 2496 is the active device in the control panel.”

Audiophile 2496 Recording Tutorial

In this section we will explore a sample setup for recording and playback using the Audiophile 2496 Digital Recording Interface. This is by no means an exhaustive tutorial but its intent is to help you understand most of the Audiophile’s feature set. Before beginning, you should open your music software and profile the Audiophile 2496, enable its drivers, or otherwise setup the software for operation with the Audiophile 2496.

NOTE: All of these examples refer to the Windows MME driver names. If you’re using ASIO or Apple Sound Manager drivers, you’ll need to substitute the appropriate driver names when referring to software inputs or outputs. On the Macintosh, substitute “SM/ASIO” for Delta Control Panel references to “WavOut.”

Typical Setup

Let’s look at a setup that involves a typical transfer of information from DAT to computer and back to DAT. Here, we’ll be using the Audiophile’s S/PDIF I/O along with the analog output stereo pair.

NOTE: Because improper connections can potentially make very loud noises, it’s a good idea to have monitor levels down while hooking up audio equipment — you may even choose to turn your computer off before making the connections.

In this example, we will connect a DAT to the Audiophile 2496 break-out cable’s S/PDIF connectors using coaxial S/PDIF cables (75-ohm impedance RCA-to-RCA). We’ll also connect the Audiophile’s analog outputs to a sound system for monitoring purposes. A setup like this might be used to transfer a number of mixes from a DAT into an audio editing program, performing the appropriate edits, and then transferring the edited material back to DAT.

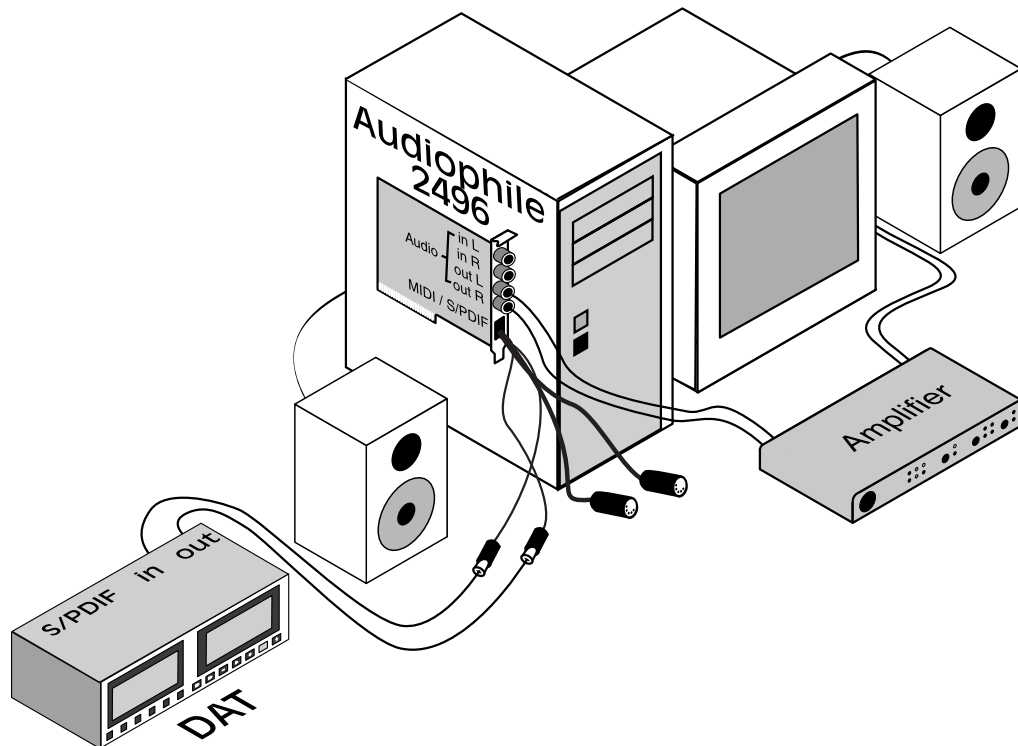

The example below may at first look long and laborious, but you will find that most of the settings are factory defaults and will rarely need to be modified.

Transferring from DAT to Audiophile 2496

1. Connect the DAT's coaxial S/PDIF output to the S/PDIF In of the Audiophile 2496 break-out cable, using a good quality cable.

Connect the Audiophile 2496 analog outputs to some type of amplified sound system. The sound system should be equipped with speakers or headphones. From the Delta Control Panel, set the proper output signal levels "Consumer" or "-10dBV" to be compatible with that sound system's inputs.

3. Because you will be recording from the S/PDIF input, you will need to set up the Audiophile 2496 to synchronize its master clock with the S/PDIF input. To do this, open the Hardware Settings page of the Delta Control Panel software. Under Master Clock, select "S/PDIF In."
4. Next, you will need to tell your application software the expected sample rate. We'll use 44.1 kHz in this example. Therefore, on the Hardware Settings page, set the "S/PDIF Sample Rate" to 44,100.
5. In order to monitor the digital signal coming into the Audiophile 2496, switch to the Patchbay/Router page of the Delta Panel software. In the "H/W Out 1/2" column, select the radio button labeled "S/PDIF In." This will copy all incoming S/PDIF audio directly to the analog outputs. Therefore, in this example, the

monitor mixer will be completely bypassed. Once this assignment is made, you may play the DAT material at any time and verify that it is making it into the Audiophile 2496 successfully, by listening to the sound system. This can be done regardless of whether or not your recording software is open.

Within your recording software, select “S/PDIF In Delta-AP,” as the audio input device. The Delta input appears as a stereo pair.

7. Start your software recording and then start your DAT material playing. You should be able to hear the DAT material through your sound system.

Transferring from Audiophile 2496 to DAT, monitoring with DAT

1. Connect the Audiophile’s S/PDIF Out to the DAT’s coaxial S/PDIF Input using a good quality cable.
2. Connect the DAT analog outputs to some type of amplified sound system. The sound system should be equipped with speakers or headphones.
3. Because you will be playing back at the recorded sample rate, you will want to set the Audiophile’s master clock to use the Audiophile’s internal crystal. Do this by opening the Hardware Settings page of the Delta Control Panel software and under Master Clock, selecting “Internal Xtal.” Also, under the Codec Sample Rate section you should uncheck “Rate Locked” if it is previously checked. This allows for more flexible sample rate playback.
4. In order to verify proper S/PDIF Output routing, open the Patchbay/Router page of the control panel software. In the “H/W Out S/PDIF” column, select the radio button named “WavOut S/PDIF.” Now everything that is sent by your software to the “WavOut S/PDIF” device will be routed to the hardware S/PDIF output, and consequently to the DAT.
5. Next let’s make sure the S/PDIF output format is correct. Open the S/PDIF page of the control panel software. Under Digital Output Format, choose “Consumer.” Uncheck “Advanced” if it is checked previously. Now click on the “Restore Defaults” button to set the default S/PDIF outgoing status bits. This will disable copy protection and also set the emphasis to “none,” allowing the DAT to accept and record the audio properly.
6. Within your recording software, select “WavOut S/PDIF Delta-AP” as the audio output device.
7. Start your DAT recording and then start your software playing. You should be able to hear the DAT material through your sound system. This verifies that the digital audio is making it into the DAT correctly.

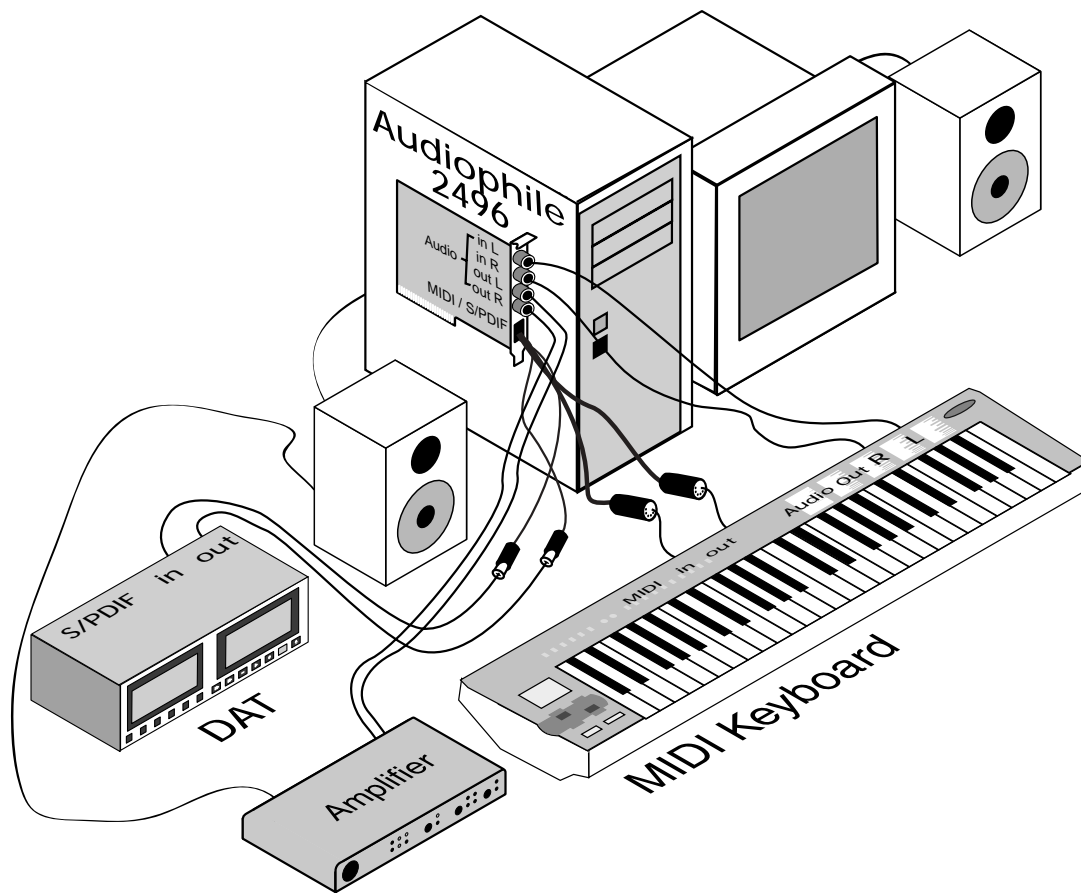

Audiophile 2496 MIDI Setup

The Audiophile's MIDI input and output ports may be connected to external MIDI devices. The diagram below shows connection to a MIDI controller keyboard, which is also being used as a sound module. The MIDI output of the Audiophile 2496 may be used with just a sound module, while the MIDI input may alternately be used to receive MIDI timecode for synchronization purposes.

1. Connect the MIDI out port of your controller keyboard to the MIDI In of the Audiophile breakout cable using a standard MIDI cable.
2. Connect the MIDI Out port of the Audiophile breakout cable to the MIDI in of your controller keyboard, also using a standard MIDI cable.
3. Connect the audio outputs of the keyboard to either a mixer, sound system, or the audio inputs of the Audiophile 2496 card.

Troubleshooting Tips for Frequently Asked Questions

Problem: No Sound.

Possible Cause 1: The Audiophile 2496 hardware or software device drivers are not properly installed. See the installation sections of this manual for further information.

Possible Cause 2: There is a resource conflict between the Audiophile 2496 and another device in your computer. Check the Audiophile 2496 configuration (Address, IRQ) against those of the other installed devices. If necessary, change the settings for the one or more of the devices.

Possible Cause 3: Your application software has not been properly configured to use the Audiophile 2496 as its audio output device.

Possible Cause 4: Misrouted outputs in the Delta Control Panel. Check the Delta Control Panel's Patchbay/Router page to verify output routing assignments. Also, make sure that if the output is routed from the digital mixer, that the mixer's faders, solo and mute controls are set up properly.

Possible Cause 5: Improper connections of the audio accessories. Verify that the Audiophile 2496 analog audio outputs are properly connected to a digital mix deck or external mixer/amplifier, or the S/PDIF Out is connected to an external digital audio device capable of receiving S/PDIF.

Problem: No visual activity on Audio Input volume (VU) meters of user software.

Possible Cause 1:: The Audiophile 2496 input devices are not properly selected in the user's application software.

Possible Cause 2:: If the software is recording from the Audiophile's monitor mixer device, be sure that the mixer's faders, solo and mute controls are set up properly.

Possible Cause 3:: Improper connections to audio accessories.

Problem: Repetitious Sound.

Possible Cause: An IRQ resource conflict. Often this will result in a small segment of sound (0.5 to 1 second) repeating itself over and over, sometimes completely locking up the computer. See the general troubleshooting suggestions at the beginning of this section.

Problem: I'm getting some pops and clicks in my audio recording.

Possible Cause 1:: Input levels are too "hot," causing clipping or input distortion. Make sure you have the proper signal levels coming from your source audio device, and lower the output if necessary. The incoming levels may be easily viewed from the Delta Control Panel peak meters.

Possible Cause 2:: Your application software may not have the proper audio buffer sizes set. Each software application handles this differently, but typically there is somewhere in the software's setup to set the size of the playback and recording buffers used by the application. Some applications also require you to run

a card calibration (sometimes called “profiling”) the first time you use the software with a new audio card.

Possible Cause 3: Some accelerated graphics cards use excessive amounts of system bandwidth, preventing the recording buffer of an audio card from keeping up with demand. This can cause clicks in the recording. Reducing or turning off the graphics card’s graphics acceleration feature often resolves this problem. In Windows, the level of graphics acceleration is accessed from Start | Settings | Control Panel | System | Performance | Graphics.

Problem: The sound from the monitor mixer is muffled. It sounds as if it were running through a mixer with the treble control turned all the way down!

Possible Cause: The current Audiophile 2496 sample rate is too low. The monitor mixer is a digital device that runs at the current sample rate of the Audiophile 2496 board. The frequency response of the mixer is roughly one-half of the sample rate. There is no way to prevent this lost frequency response while playing back or recording at a low sample rate. However, it may be prevented when the system is idle. See the “CODEC SAMPLE RATE” paragraph of the section ‘Hardware Settings Page’ for more information.

Problem: My software application keeps telling me “sample rate not supported” or some similar message.

Possible Cause: You have “Rate Locked” set in the Delta Control Panel. This makes only the sample rate specified in the panel available to Windows and software applications. Either uncheck “Rate Locked” or set your application to that locked sample rate.

Problem: Clicking sounds occur at the beginning of and immediately after each sound.

Possible Cause: Sample rate changes often cause clicks and pops to occur in the audio. These sample rate changes can happen at the start and end of audio playback. If “Reset Rate When Idle” is checked under the Hardware page of the Delta Control Panel software, the Audiophile is changing its sample rate back to a specified rate each time a sound ends. Then if a sound starts again at a different sample rate, the Audiophile clock is changed again to meet that new sample rate. To eliminate this, uncheck the “Reset Rate When Idle” checkbox.

Problem: I am playing AC-3 or surround sound data from a software application on my computer, sending the data from Audiophile S/PDIF Out to my home theatre’s AC-3 decoder. However, the decoder does not recognize the signal and therefore refuses to put out any audio.

Possible Cause: There is a bit within the S/PDIF digital audio stream that defines the S/PDIF content as audio or non-audio. Most AC-3 surround sound decoders expect this setting to be non-audio and will otherwise reject the information. Go to the S/PDIF page of the Delta Control Panel, select Consumer and Advanced Settings, and then select “Non-Audio” as the data type.

Appendix A - Technical Specs

Analog Audio

Peak Analog Input Signal:	+2dBV.
Peak Analog Output Signal:	+2dBV (Consumer setting), -4dBV (-10dBV setting).
Max Converter Data Width:	24 bits.
Dynamic Range:	
Outputs:	104dB (a-weighted).
Inputs:	100.4dB (a-weighted).
THD (at 0dBFS):	less than 0.002%,
Frequency Response:	22Hz - 22kHz, -0.4,-0.4dB.
Input Impedance:	10k ohms minimum.
Connectors:	Gold-plated RCA female, on PCI card.

Digital Audio

Maximum Word Width:	24 bits.
Digital Input Format:	S/PDIF coaxial, 0.5V to 5V peak-to-peak.
Digital Input Sample Rate:	8kHz to 96kHz.
Digital Output Format:	S/PDIF coaxial, 0.5V peak-to-peak; AES/EBU data stream over S/PDIF coaxial.
Digital Output Sample Rate:	8kHz to 96kHz.
Connectors:	Gold-plated RCA, female, on break-out cable.

MIDI

I/O Configuration:	1-in, 1-out; 16 MIDI channels in and out.
Connectors:	Standard MIDI 5-pin DIN on break-out cable.

Adapter Resource Requirements (PC only)

IRQ:	One required
I/O Addresses:	Four blocks: 32, 16, 16, and 64 bytes
DMA Channels:	None required

Limited Lifetime Warranty

MIDIMAN warrants that this product is free of defects in materials and workmanship under normal use so long as the product is: owned by the original purchaser; the original purchaser has proof of purchase from an authorized MIDIMAN dealer; and the purchaser has registered his/her ownership of the product by sending in the completed warranty card.

This warranty explicitly excludes power supplies and included cables which may become defective as a result of normal wear and tear.

In the event that MIDIMAN receives written notice of defects in materials or workmanship from such an original purchaser, MIDIMAN will either replace the product, repair the product, or refund the purchase price at its option. In the event any repair is required, shipment to and from MIDIMAN and a nominal handling charge shall be born by the purchaser. In the event that repair is required, a Return Authorization number must be obtained from MIDIMAN. After this number is obtained, the unit should be shipped back to MIDIMAN in a protective package with a description of the problem and the Return Authorization clearly written on the package.

In the event that MIDIMAN determines that the product requires repair because of user misuse or regular wear, it will assess a fair repair or replacement fee. The customer will have the option to pay this fee and have the unit repaired and returned, or not pay this fee and have the unit returned unrepaired.

The remedy for breach of this limited warranty shall not include any other damages. MIDIMAN will not be liable for consequential, special, indirect, or similar damages or claims including loss of profit or any other commercial damage, even if its agents have been advised of the possibility of such damages, and in no event will MIDIMAN's liability for any damages to the purchaser or any other person exceed the price paid for the product, regardless of any form of the claim. MIDIMAN specifically disclaims all other warranties, expressed or implied. Specifically, MIDIMAN makes no warranty that the product is fit for any particular purpose.

This warranty shall be construed, interpreted, and governed by the laws of the state of California. If any provision of this warranty is found void, invalid or unenforceable, it will not affect the validity of the balance of the warranty, which shall remain valid and enforceable according to its terms. In the event any remedy hereunder is determined to have failed of its essential purpose, all limitations of liability and exclusion of damages set forth herein shall remain in full force and effect.