

PATRON Poche PAYSANNE 3cm

PATRONNAGE :

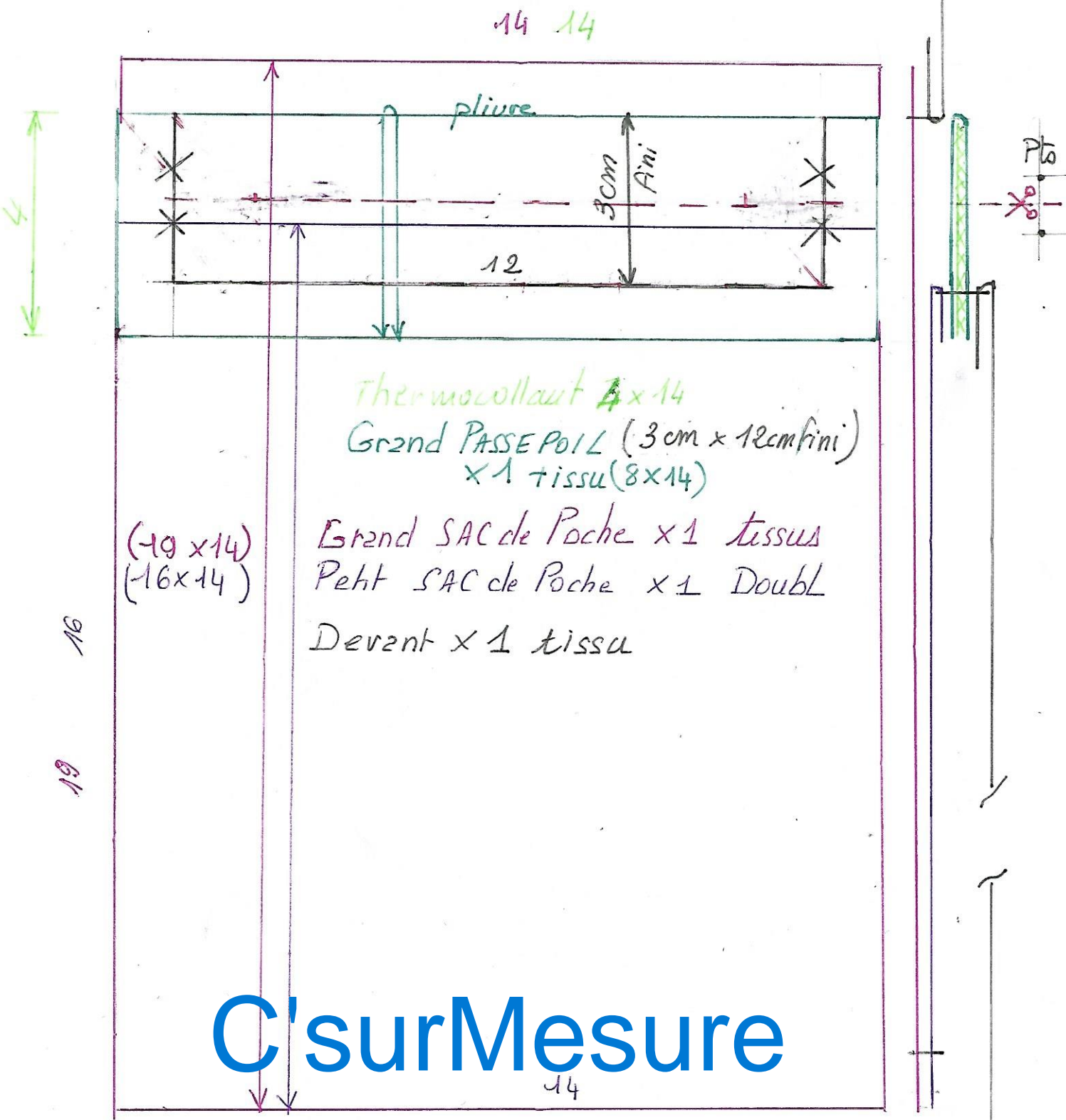

C'surMesure

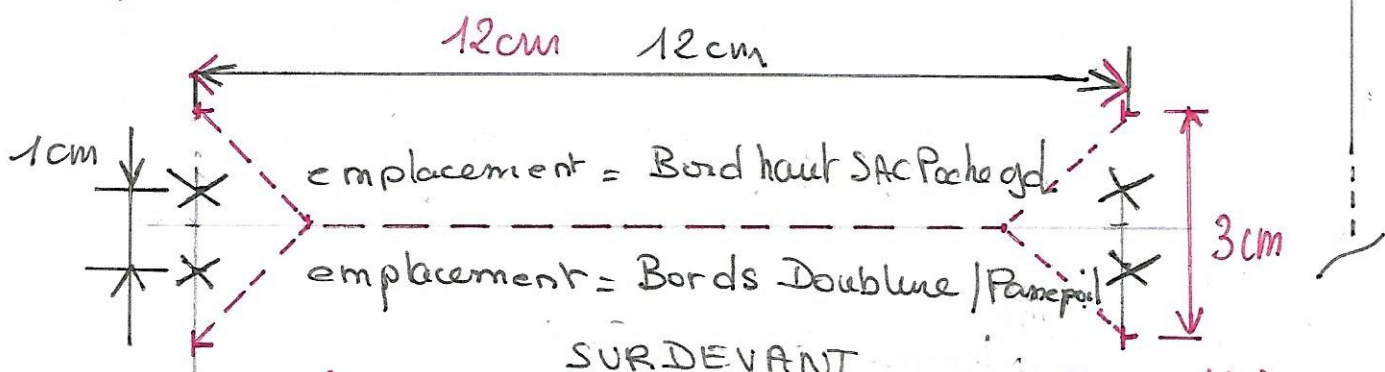

Ligne coupe capucins (ouverture Passepoil)

Dessin Technique

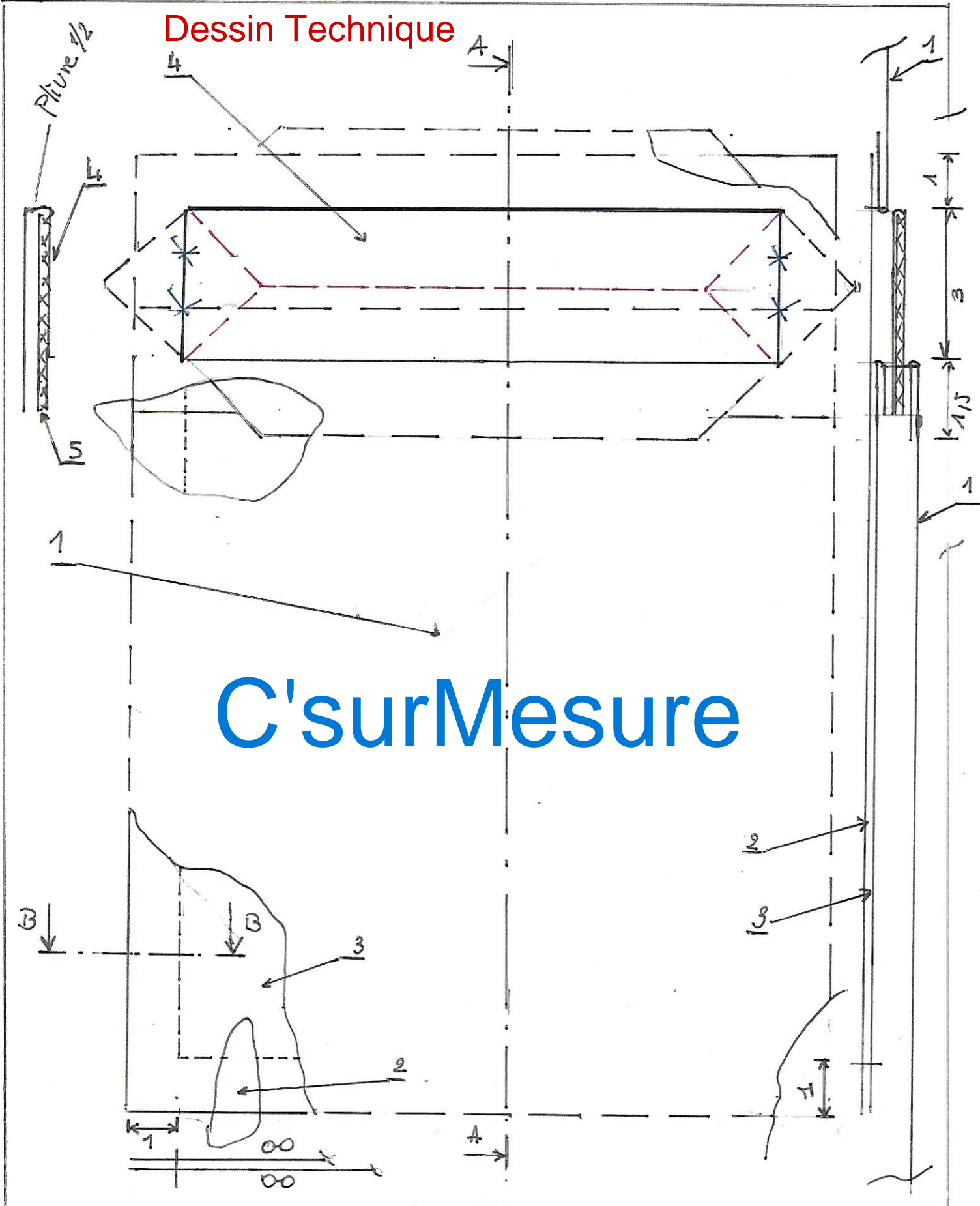

C'surMesure











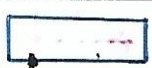

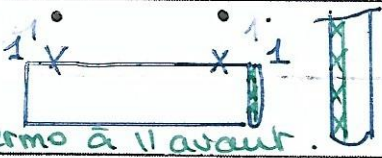

5	1	renfort Passepoil	+ hermécollant	4 x 14
4	1	Passepoil LARGE	tissu 3	3 x 12 fini
3	1	Petit fond Poche	doublure	16 x 14 coupé
2	1	Grand fond Poche	tissu 2	19 x 14 coupé
1	1	Devant	tissu 1	

POCHE PAYSANNE 3cm

Montage :

301 FER

C'surMesure

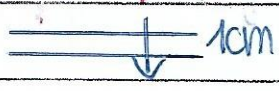
N°	Désignation	Schémas couture	Tps/Mach	Observations
1	thermocoller Passepoil		Fer	en moitier côté Avant.
2	Tracer emplacement poche		Crayon Fin	12
3	Vérifier emplacement Pts			1 1 1 sur O devant
4	PLIER et repasser Passepoil sur O		Fer	en 1/2
5	Positionner, aligner Passepoil aux Pts			
6	Repositionner le petit fond			thermo à l'avant.
7	Plaquez Fond; Passepoil à l'ut		301	à 1cm des Bords.
8	Contrôler l'ongueur et marge de couture			12cm
9	Positionner, aligner le gd fond			en face du pt fond aligner sur les Pts.
10	Plaquez le gd fond sur l'ut		301	à 1cm du Bord.
11	Vérifier sur l'envers.	coutures //		12 3
12	retourner O			
13	Fendre sur O ou OO			à 1mm de couture
14	Ressorir la Poche par la fente		Fer	sur l'envers du travail
15	Repasser les coutures		Fer	Passepoil et petit fond
16	Rabattre le gd fond sur petit			Bien superposer les fonds l'un sur l'autre.
17	Repasser Poche		301	
18	Rabattre devant			le Pong de chaque capucin
19	Maintenir les capucins			Pique le Pong
20	fermer les Fonds		301	deux capucins à l'autre. assembler les sacs.
21	contrôler	ASSEMBLAGE de la Poche + Repasser		

Patrons fonds poche

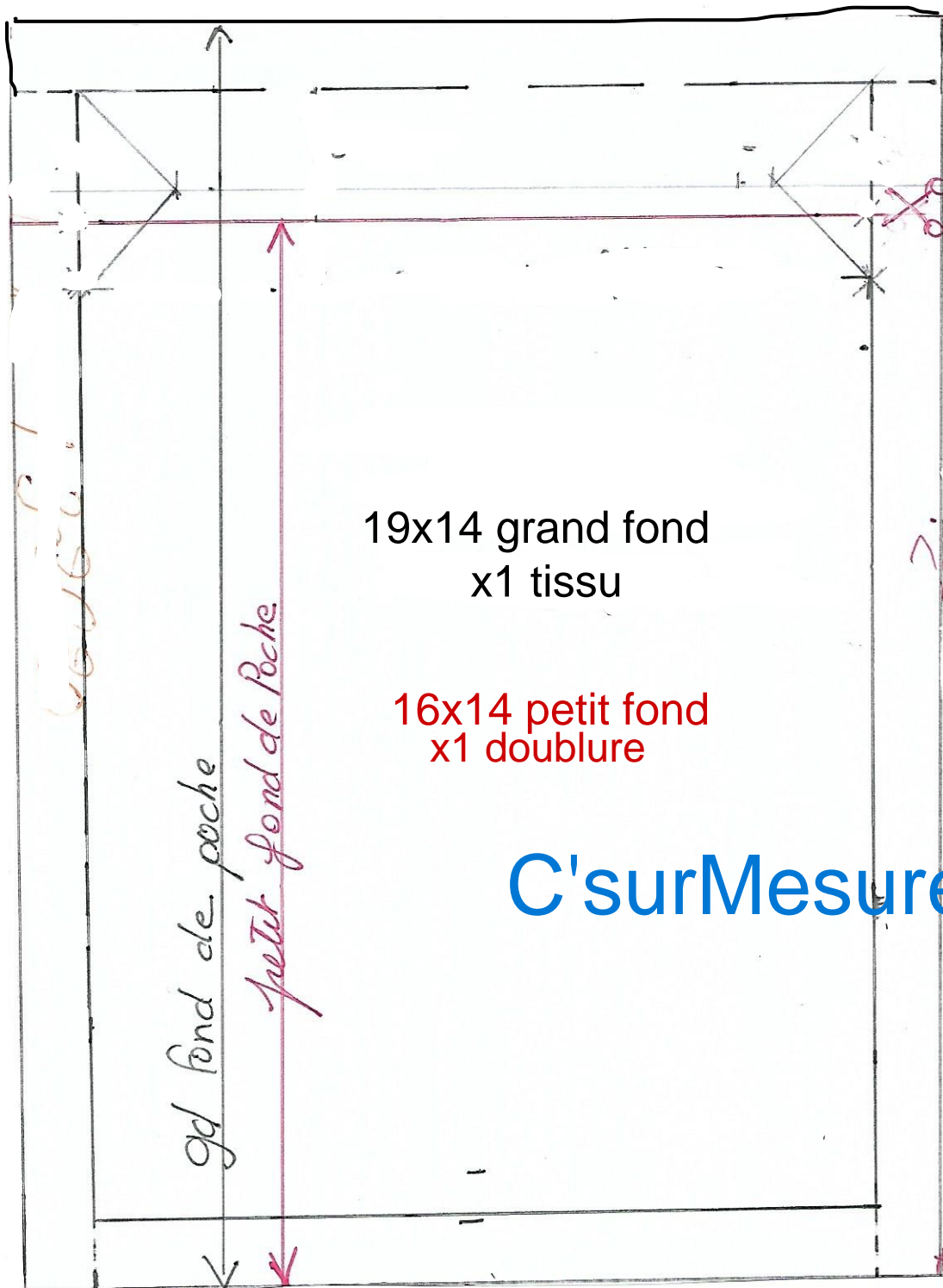

patron poche paysanne 3cm

patron poche paysanne 3cm

Patron piece principale = 20x20

tracer ligne - - - - à env 7cm du haut

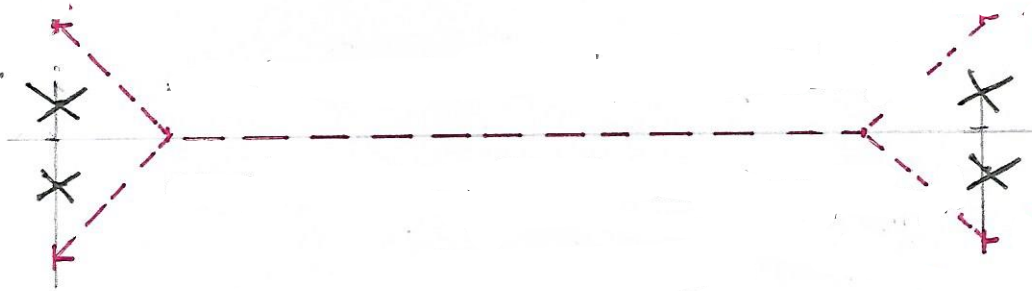

C'surMesure

patron thermocollant passepoil : 4x14cm

patron passepoil : 14x8 cm

