

Mon carnet de nombres

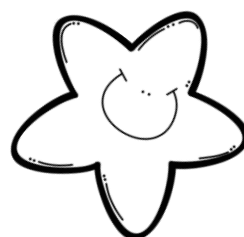

Date: _____ 20__

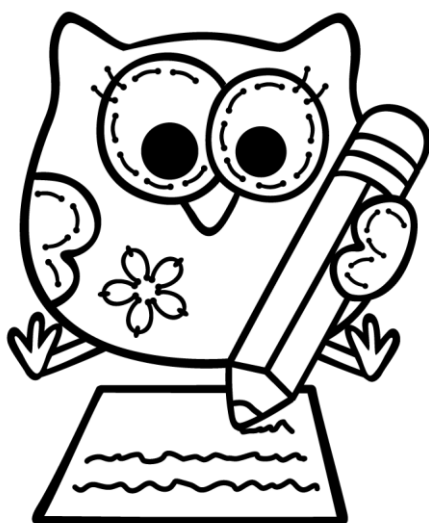
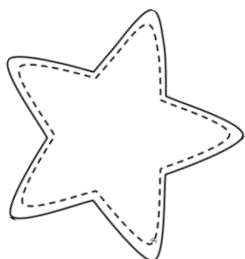
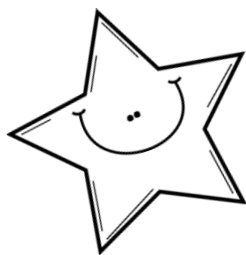
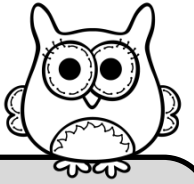

Aujourd'hui, c'est notre _____ jour de classe!

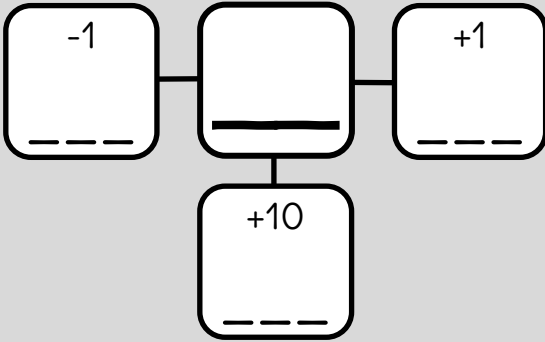

En lettres: _____

..... +

_____ d et _____ u

0	1	2	3	4	5	6	7	8	9	10	11	12	13	14	15	16
---	---	---	---	---	---	---	---	---	---	----	----	----	----	----	----	----

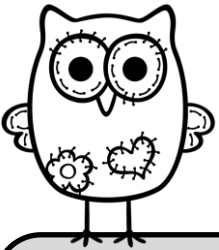

Date: _____ 20__

Aujourd'hui, c'est notre _____ jour de classe!

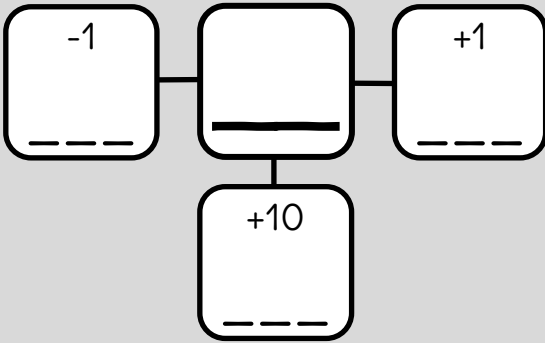

En lettres: _____

..... +

_____ d et _____ u

0	1	2	3	4	5	6	7	8	9	10	11	12	13	14	15	16
---	---	---	---	---	---	---	---	---	---	----	----	----	----	----	----	----

Date: _____ 20 ____



Aujourd'hui, c'est notre _____ jour de classe!

En lettres: _____

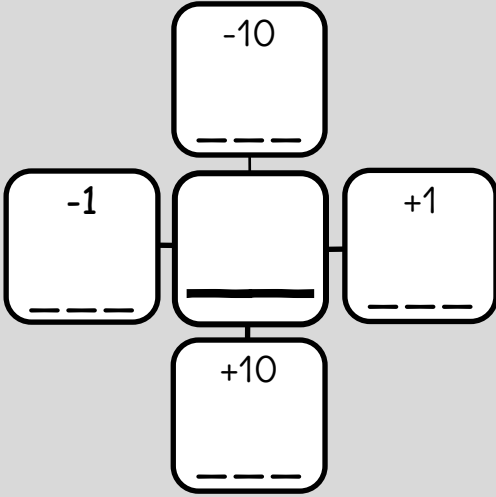

..... +

_____ d et _____ u

_____ + _____

5 6 7 8 9 10 11 12 13 14 15 16 17 18 19 20 21

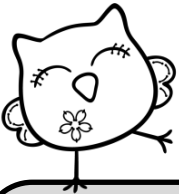

Date: _____ 20 ____

Aujourd'hui, c'est notre _____ jour de classe!

En lettres: _____

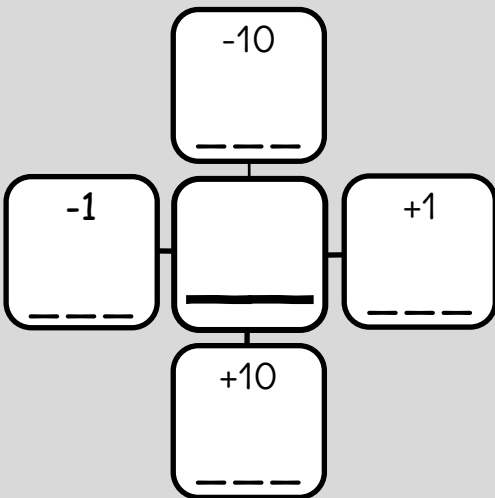

..... +

_____ d et _____ u

_____ + _____

5 6 7 8 9 10 11 12 13 14 15 16 17 18 19 20 21

Date: _____ 20 ____

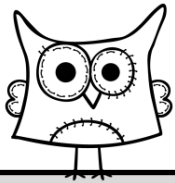

Aujourd'hui, c'est notre _____ jour de classe!

En lettres: _____

..... +

_____ d et _____ u

_____ + _____ + _____

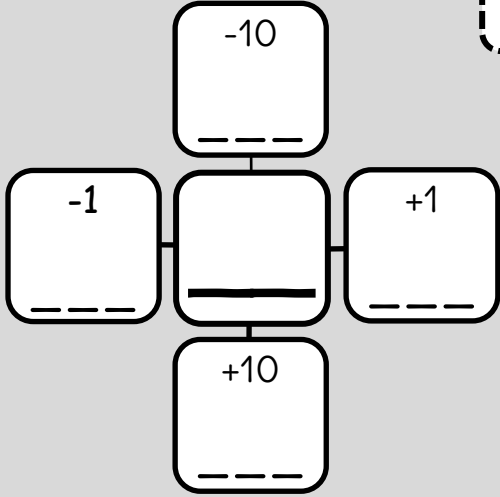

17	18	19	20	21	22	23	24	25	26	27	28	29	30	31	32	33
----	----	----	----	----	----	----	----	----	----	----	----	----	----	----	----	----

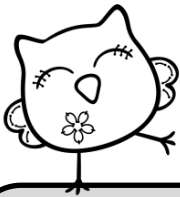

Date: _____ 20 ____

Aujourd'hui, c'est notre _____ jour de classe!

En lettres: _____

..... +

_____ d et _____ u

_____ + _____ + _____

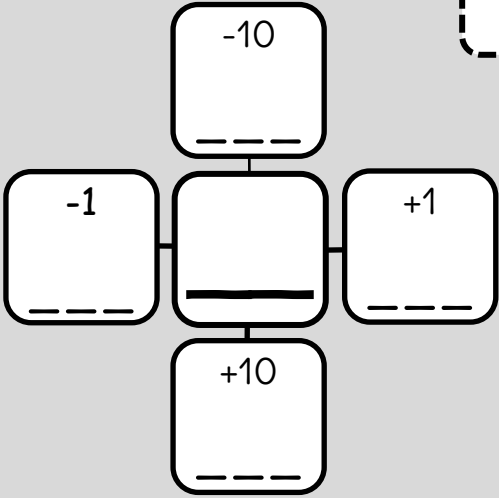

17	18	19	20	21	22	23	24	25	26	27	28	29	30	31	32	33
----	----	----	----	----	----	----	----	----	----	----	----	----	----	----	----	----

Date: _____ 20 ____



Aujourd'hui, c'est notre _____ jour de classe!

En lettres: _____

..... +

_____ d et _____ u

_____ + _____ + _____ + _____

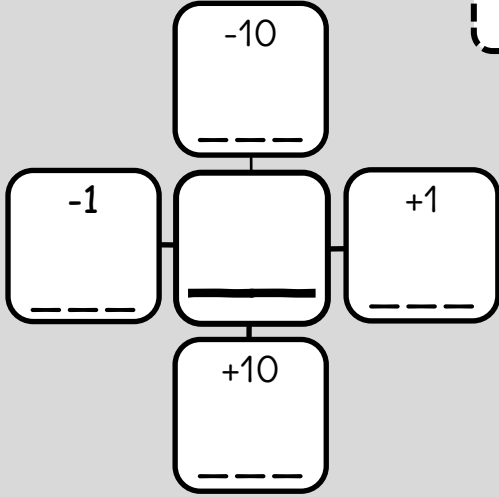

26	27	28	29	30	31	32	33	34	35	36	37	38	39	40	41	42
----	----	----	----	----	----	----	----	----	----	----	----	----	----	----	----	----

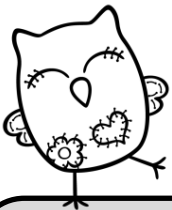

Date: _____ 20 ____

Aujourd'hui, c'est notre _____ jour de classe!

En lettres: _____

..... +

_____ d et _____ u

_____ + _____ + _____ + _____

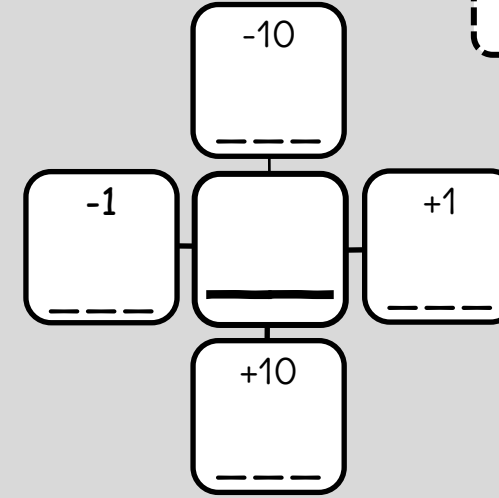

26	27	28	29	30	31	32	33	34	35	36	37	38	39	40	41	42
----	----	----	----	----	----	----	----	----	----	----	----	----	----	----	----	----

Date: _____ 20 ____

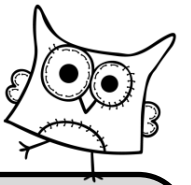

Aujourd'hui, c'est notre _____ jour de classe!

En lettres: _____

..... +

_____ d et _____ u

_____ + _____ + _____ + _____ + _____

37 38 39 40 41 42 43 44 45 46 47 48 49 50 51 52 53



Date: _____ 20 ____

Aujourd'hui, c'est notre _____ jour de classe!

En lettres: _____

..... +

_____ d et _____ u

_____ + _____ + _____ + _____ + _____

37 38 39 40 41 42 43 44 45 46 47 48 49 50 51 52 53

Date: _____ 20 ____



Aujourd'hui, c'est notre _____ jour de classe!

En lettres: _____

..... +

_____ d et _____ u

_____ + _____ + _____ + _____ + _____ + _____ + _____

46 47 48 49 50 51 52 53 54 55 56 57 58 59 60 61 62

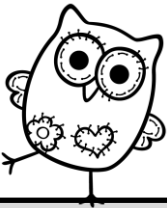

Date: _____ 20 ____

Aujourd'hui, c'est notre _____ jour de classe!

En lettres: _____

..... +

_____ d et _____ u

_____ + _____ + _____ + _____ + _____ + _____ + _____

46 47 48 49 50 51 52 53 54 55 56 57 58 59 60 61 62

Date: _____ 20 ____

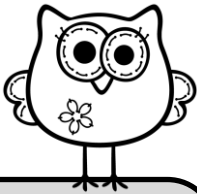

Aujourd'hui, c'est notre _____ jour de classe!

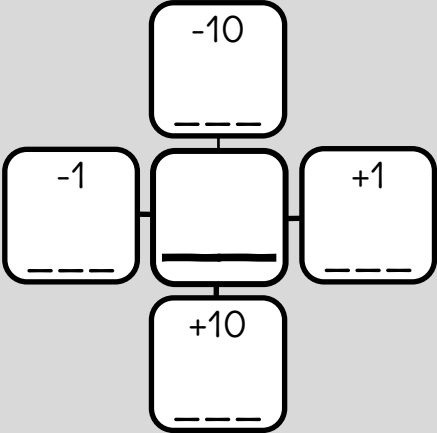

En lettres: _____

..... +

_____ d et _____ u

_____ + _____ + _____ + _____ + _____ + _____ + _____ + _____

58	59	60	61	62	63	64	65	66	67	68	69	70	71	72	73	74
----	----	----	----	----	----	----	----	----	----	----	----	----	----	----	----	----

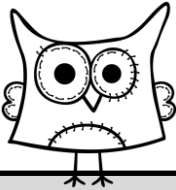

Date: _____ 20 ____

Aujourd'hui, c'est notre _____ jour de classe!

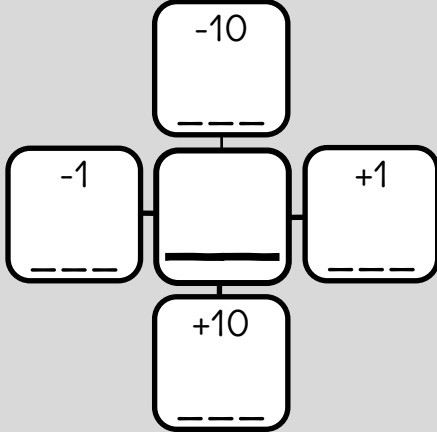

En lettres: _____

..... +

_____ d et _____ u

_____ + _____ + _____ + _____ + _____ + _____ + _____ + _____

58	59	60	61	62	63	64	65	66	67	68	69	70	71	72	73	74
----	----	----	----	----	----	----	----	----	----	----	----	----	----	----	----	----

Date: _____ 20 ____

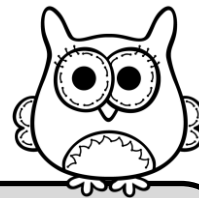

Aujourd'hui, c'est notre _____ jour de classe!

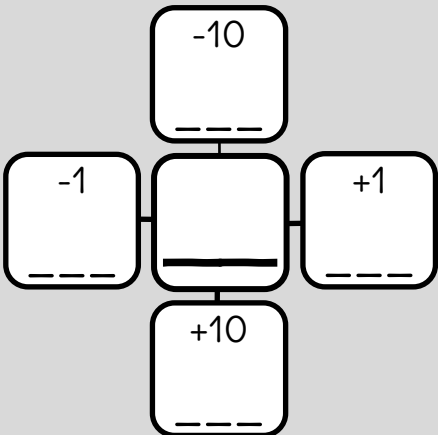

En lettres: _____

..... +

_____ d et _____ u

_____ + _____ + _____ + _____ + _____ + _____ + _____ + _____ + _____

66	67	68	69	70	71	72	73	74	75	76	77	78	79	80	81	82
----	----	----	----	----	----	----	----	----	----	----	----	----	----	----	----	----

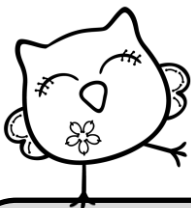

Date: _____ 20 ____

Aujourd'hui, c'est notre _____ jour de classe!

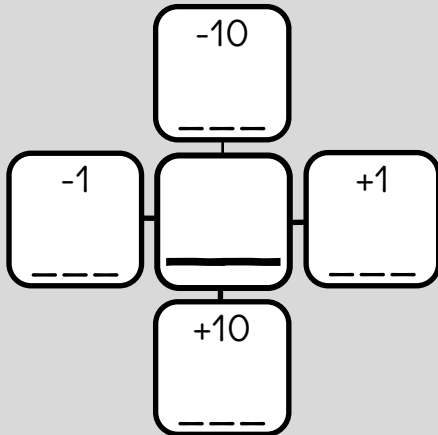

En lettres: _____

..... +

_____ d et _____ u

_____ + _____ + _____ + _____ + _____ + _____ + _____ + _____ + _____

66	67	68	69	70	71	72	73	74	75	76	77	78	79	80	81	82
----	----	----	----	----	----	----	----	----	----	----	----	----	----	----	----	----

Date: _____ 20 ____

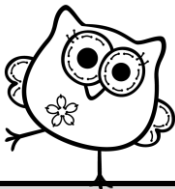

Aujourd'hui, c'est notre _____ jour de classe!

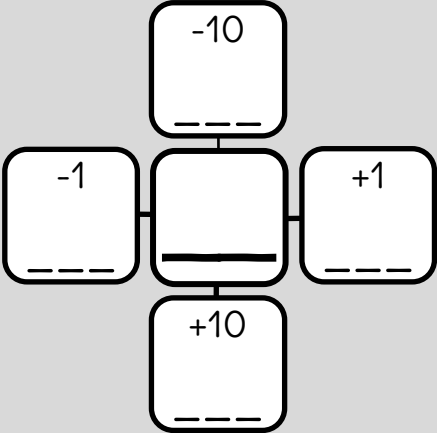

En lettres: _____

..... +

_____ d et _____ u

_____ + _____ + _____ + _____ + _____ + _____ + _____ + _____ + _____ + _____ + _____

75	76	77	78	79	80	81	82	83	84	85	86	87	88	89	90	91
----	----	----	----	----	----	----	----	----	----	----	----	----	----	----	----	----

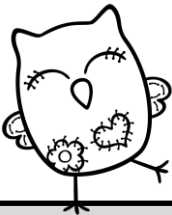

Date: _____ 20 ____

Aujourd'hui, c'est notre _____ jour de classe!

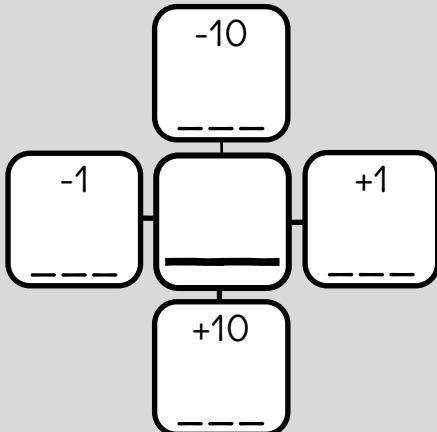

En lettres: _____

..... +

_____ d et _____ u

_____ + _____ + _____ + _____ + _____ + _____ + _____ + _____ + _____ + _____ + _____

75	76	77	78	79	80	81	82	83	84	85	86	87	88	89	90	91
----	----	----	----	----	----	----	----	----	----	----	----	----	----	----	----	----

Date: _____ 20 ____

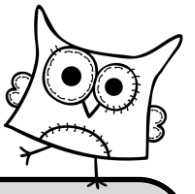

Aujourd'hui, c'est notre _____ jour de classe!

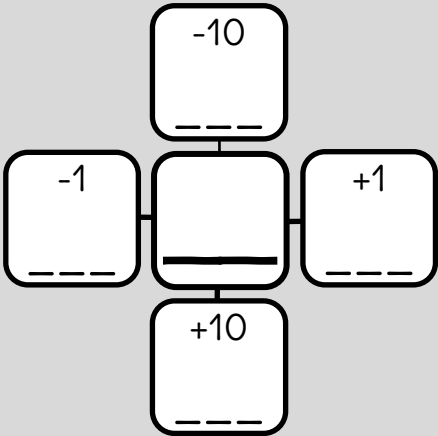

En lettres: _____

..... +

_____ d et _____ u

_____ + _____ + _____ + _____ + _____ + _____ + _____ + _____ + _____ + _____ + _____ + _____

87	88	89	90	91	92	93	94	95	96	97	98	99	100	101	102	103
----	----	----	----	----	----	----	----	----	----	----	----	----	-----	-----	-----	-----



Date: _____ 20 ____

Aujourd'hui, c'est notre _____ jour de classe!

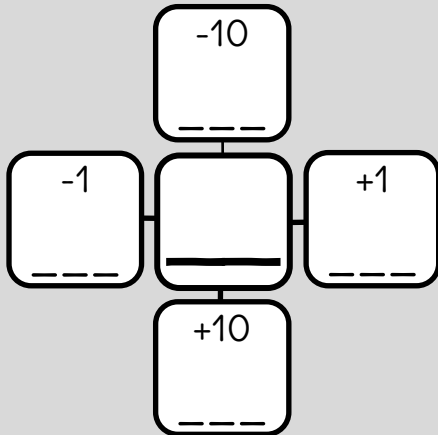

En lettres: _____

..... +

_____ d et _____ u

_____ + _____ + _____ + _____ + _____ + _____ + _____ + _____ + _____ + _____ + _____ + _____

87	88	89	90	91	92	93	94	95	96	97	98	99	100	101	102	103
----	----	----	----	----	----	----	----	----	----	----	----	----	-----	-----	-----	-----