



Easy Surgical Scrub Top Pattern



This easy surgical scrub top pattern is the final project in the surgical scrub outfit. After we published the [Unisex Scrubs Pants Pattern](#) last week, many readers asked for the matching scrubs top. So here it is!

The complete set is made for at-home use (in case you need to care for an infectious family member), or to be donated to healthcare workers. This is my little way to help in this terrible pandemic.

You can find links to all the other patterns at the bottom of the article on the website.

People that can sew are in a very unique position to help. I hope that after we pull through this, more people out there will realize the special benefits that come with this great skill of sewing.

Experience level: Beginner

You can read more about this pattern over at [So Sew Easy](#) **HERE**.

Find more great sewing patterns at So Sew Easy – <https://so-sew-easy.com>



To print your PDF pattern

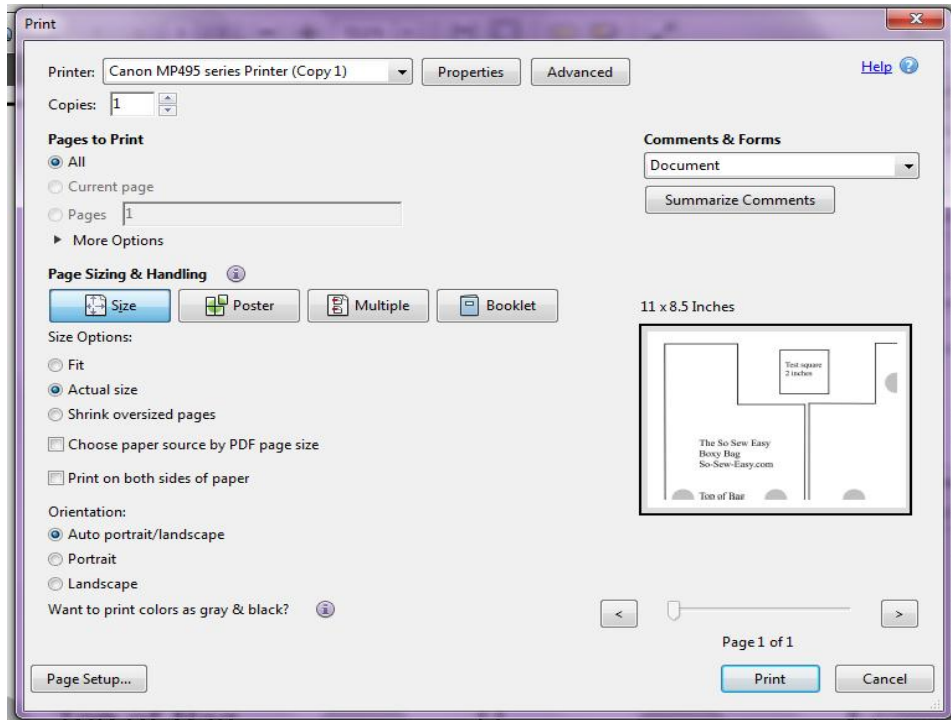

Your pattern pieces come at the end of these instructions. For accurate printing, please make sure you are using the latest version of Adobe Reader. You can [download the latest version here](#) if you need to.

Select File → Print and the print dialogue box opens. Under Page Sizing and Handling, select ACTUAL SIZE. Check the preview in the right hand side illustration. Select the page numbers you want to print. You can print the whole document, or just the pattern pieces.

On the edge of the top left page is a box you can use to test your printing. This box should measure 2 inches square. If yours is wildly different you will need to check your printer options to make sure the pages are not being resized.

Use the grey guides on the overlap of the sheets to match up the pattern pieces, folding under or cutting off any overlaps, tape together and cut out your pattern pieces.

Help printing and assembling your pattern

You can find helpful tutorials on how to download, print and assemble PDF sewing patterns here:

[How to download and print a PDF sewing pattern](#)

[How to print and assemble a PDF sewing pattern](#)

Find more great sewing patterns at So Sew Easy – <https://so-sew-easy.com>



Materials

- 1 yard of 100% cotton 60 inches wide. See my recommendations below.
- Thread to match
- 2" Bias tape (make your own)

Tools

- Sewing Machine
- Serge

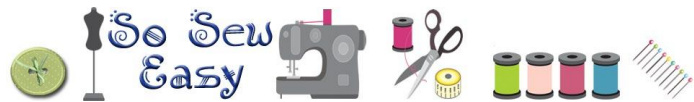

Find more great sewing patterns at So Sew Easy – <https://so-sew-easy.com>

Thank you for downloading this pattern and tutorial. I hope you enjoyed making this project and remember that I love to see what you made so do upload your completed projects to the pattern page on Blueprint.

Keep up with all the latest news and sewing projects at [So Sew Easy](#).

We also have a really great sewing chat group where you can ask questions, share your completed projects, and get 24 hr sewing inspiration. It's not just for So Sew Easy projects – you can chat about all sewing there, whether a newbie just starting out, or an advanced and experienced sewer, there's something for everyone in the sewing chat group. Join us here.

[SEWING CHAT GROUP](#)

For the latest list of both free and paid patterns available, pop on over to [my designer page on Blueprint](#).

This pattern graphic, the photos and the instructions are copyright So Sew Easy Pte Ltd and protected by law. All rights reserved. Please do not copy, publish, sell, redistribute or alter them in any way. Please don't print and give to your friends, or send it to anyone by email. Please do not rebrand this work as your own and sell or give it away, even if altered. This is intended for your personal use. If you would like to recommend these instructions, please pass on the original download link at So-Sew-Easy.com. Thank you for your understanding.

Usage – you ARE allowed to use this pattern to make things to sell on a small handmade basis, such as for craft fairs and for your Etsy shop. However, it may not be used for larger scale commercial purposes without a commercial license.

Find more great sewing patterns at So Sew Easy – <https://so-sew-easy.com>



Surgical Scrub
Top
2" X 2"
Square Test

So-Sew-Easy.com
Copyright 2020

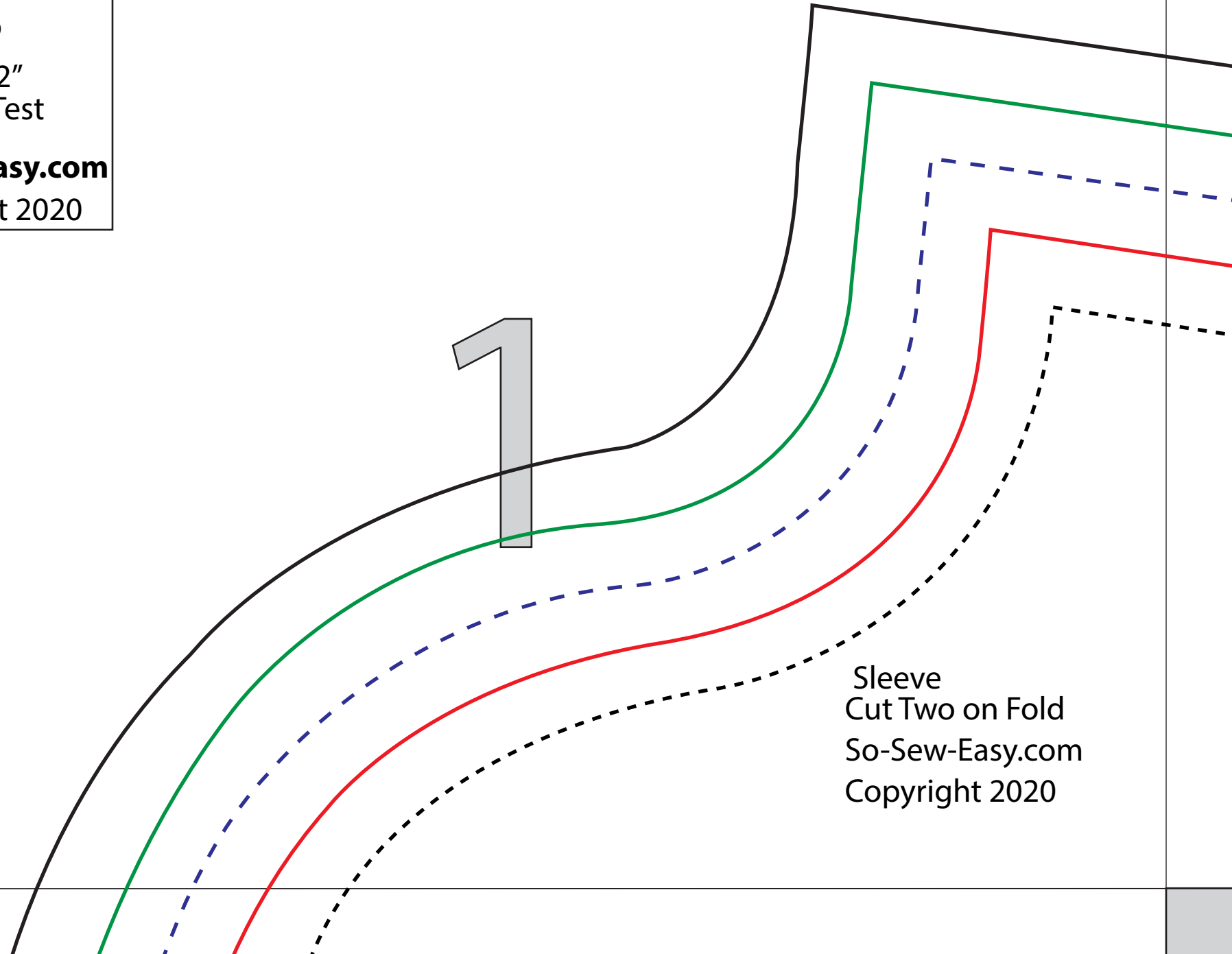

Sleeve
Cut Two on Fold
So-Sew-Easy.com
Copyright 2020

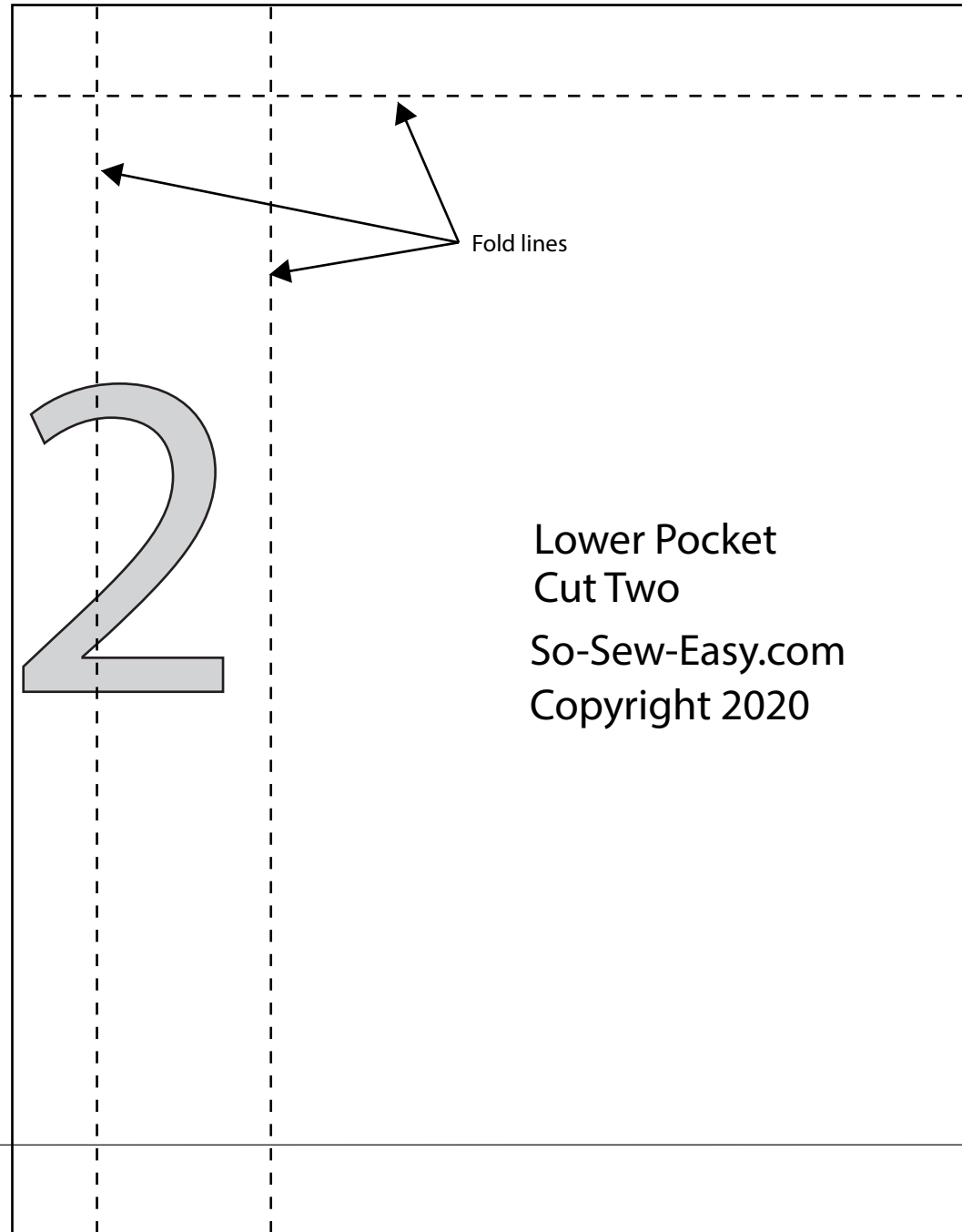
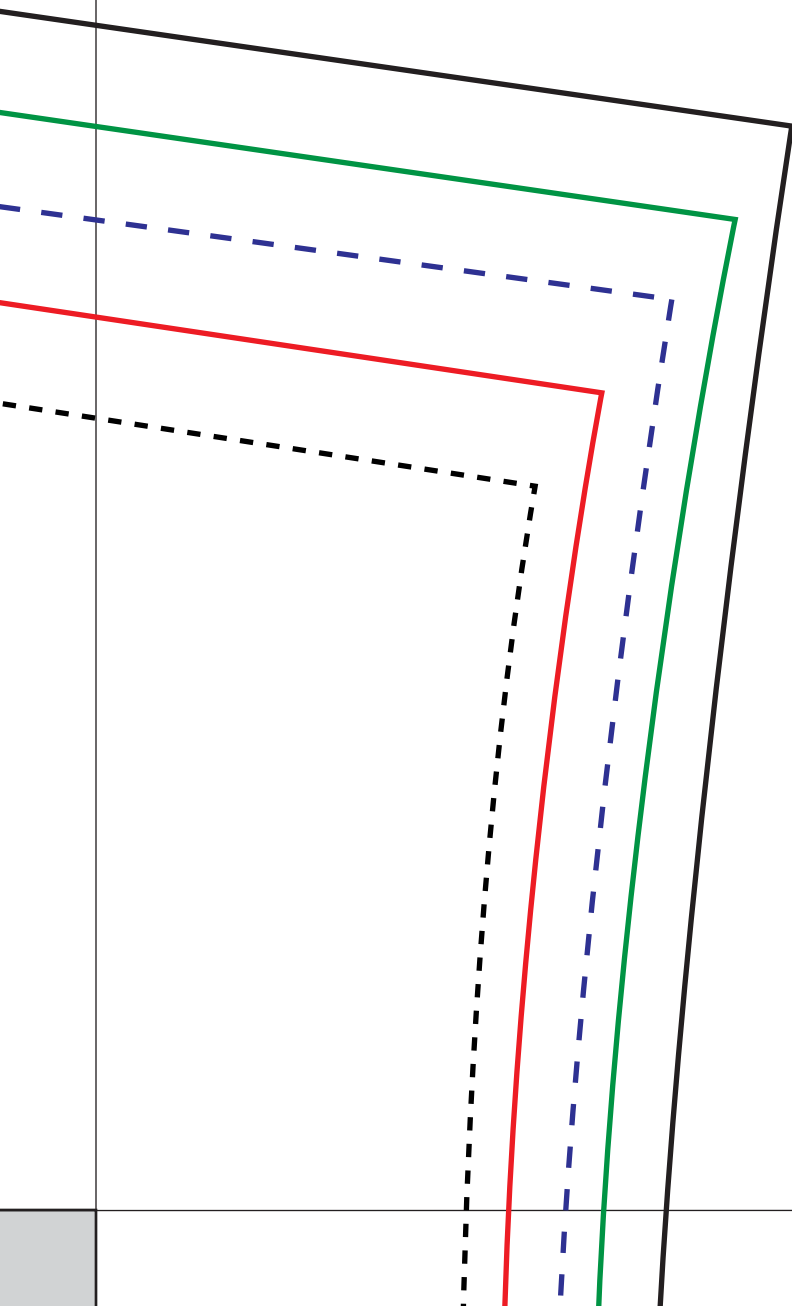

Lower Pocket
Cut Two
So-Sew-Easy.com
Copyright 2020

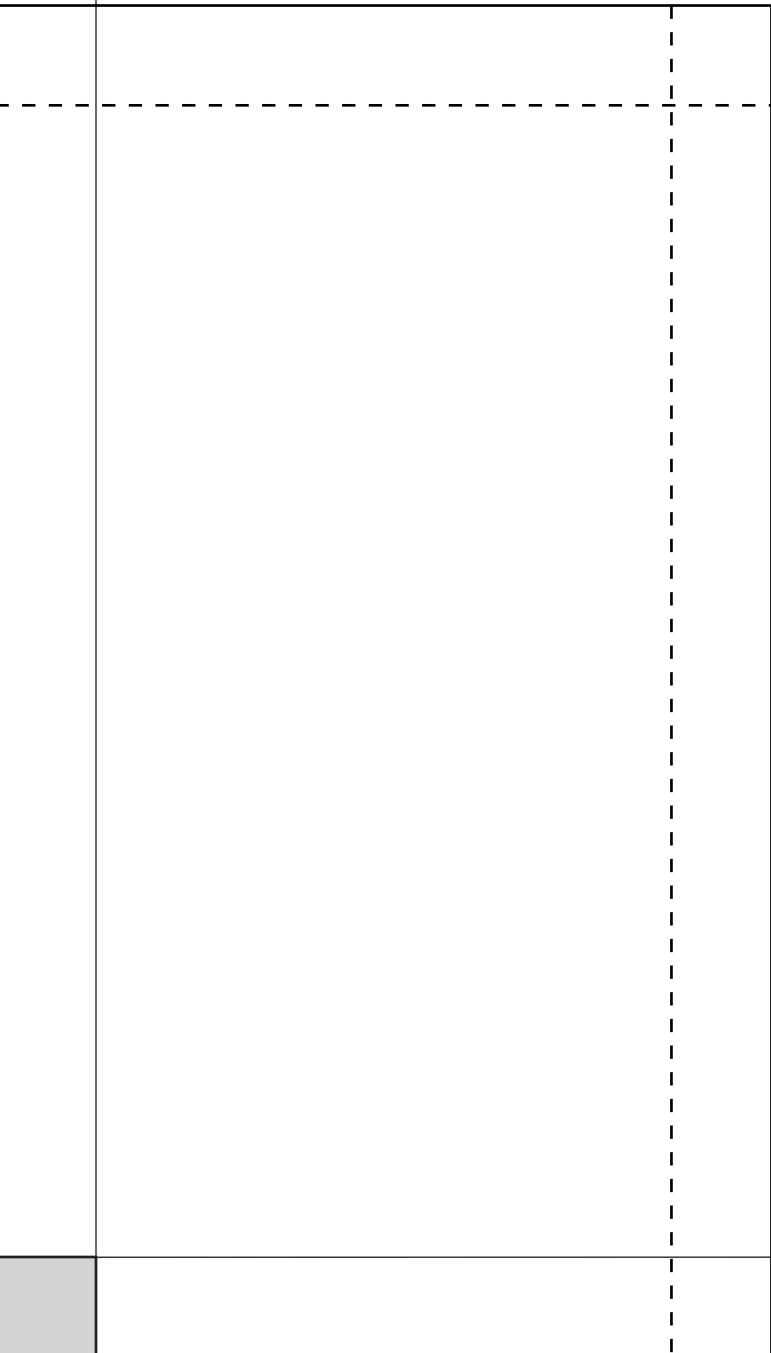

3

S 

M 

L 

XL 

2XL 

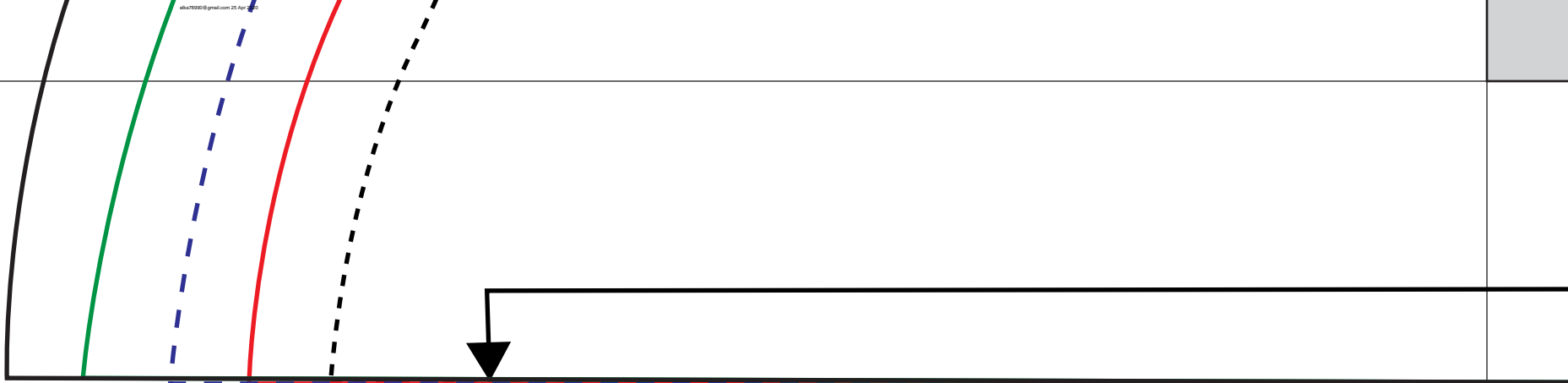

4

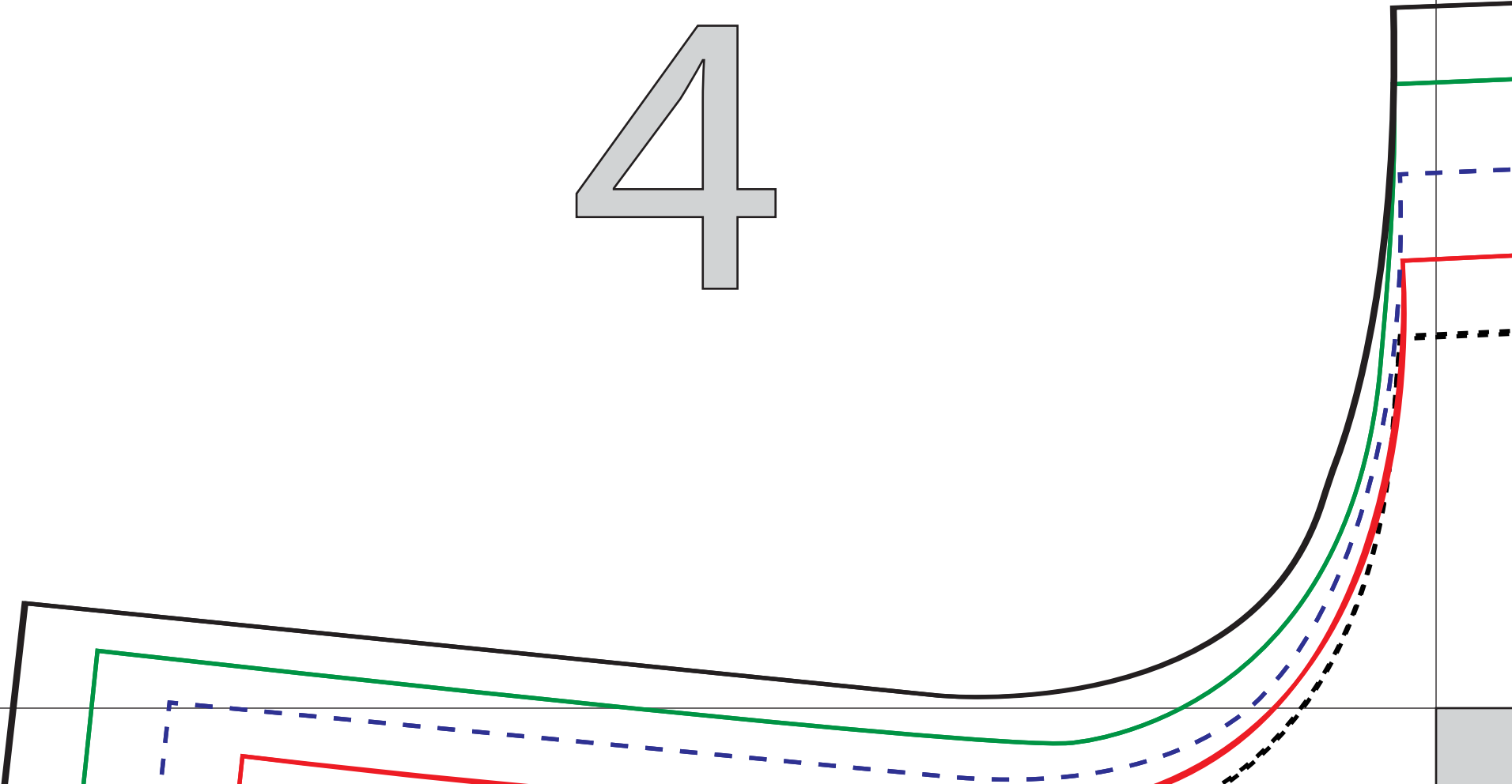

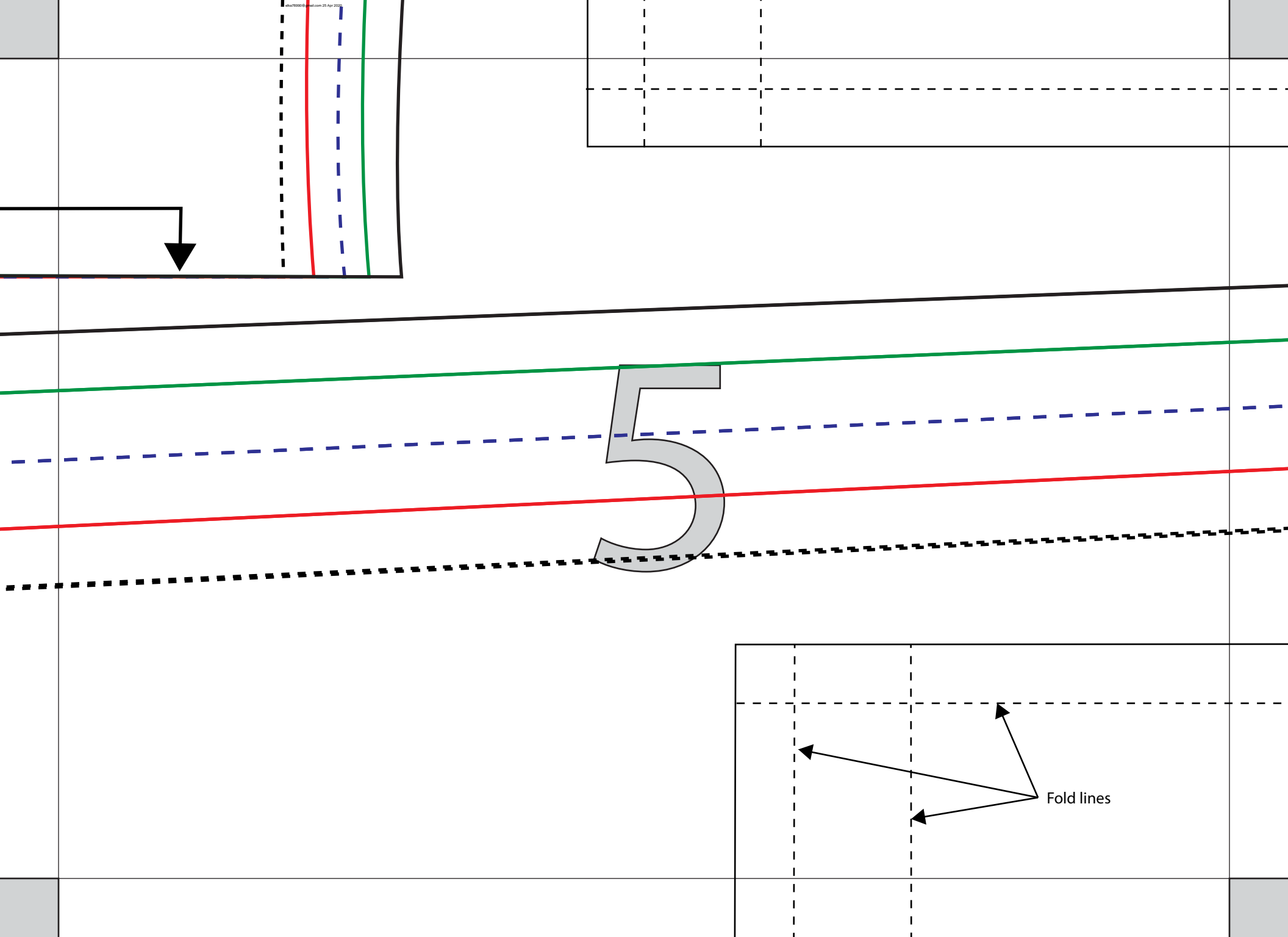

ak4789000@gmail.com 25 Apr 2025

5

Fold lines

6

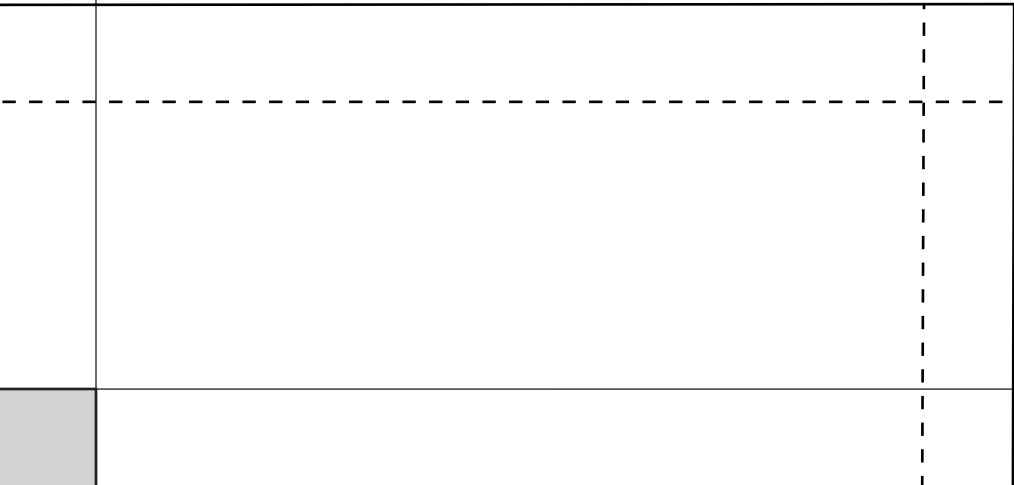
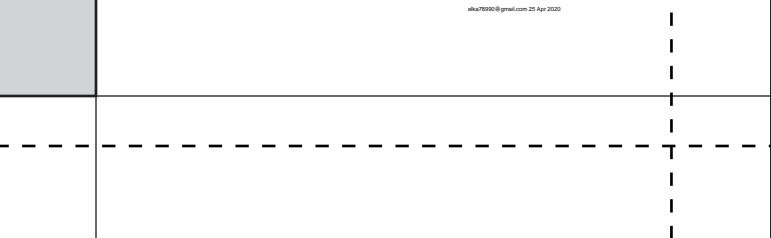
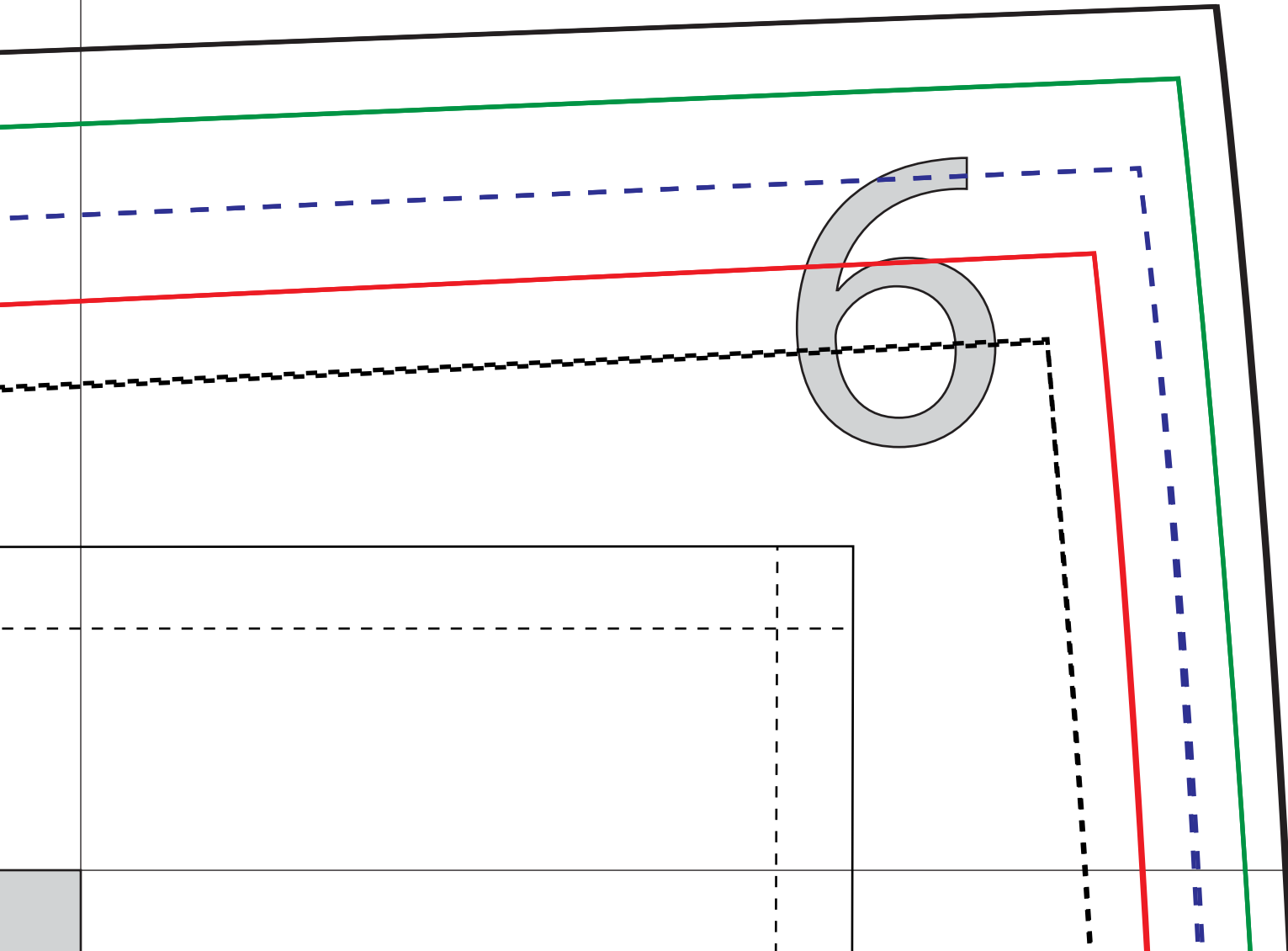

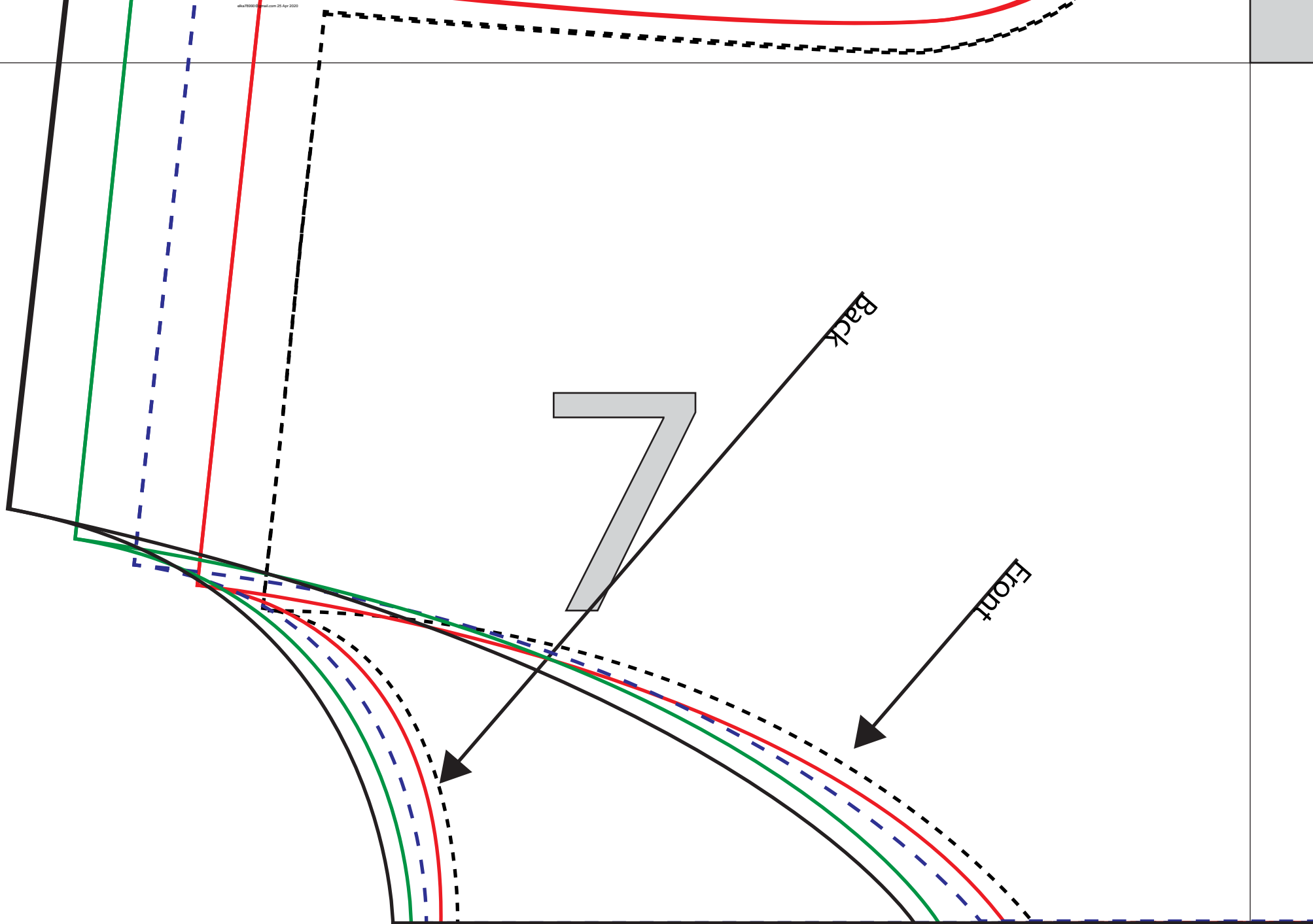

Front and Back
Cut One on Fold for Front
Cut One on Fold for Back
So-Sew-Easy.com
Copyright 2020

Chest Pocket
Cut One
So-Sew-Easy.com
Copyright 2020

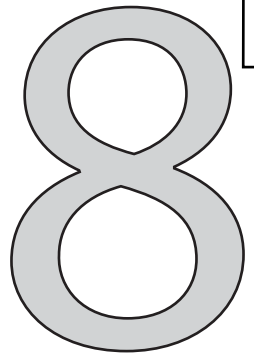

9

