

SQUARE TEST

4" x 4"
10.1 x 10.1 CMS

*On the Cutting Floor
Designs*

FRONT BODICE
ON FOLD
CUT 1
FRONT BODICE
ON FOLD
CUT 2

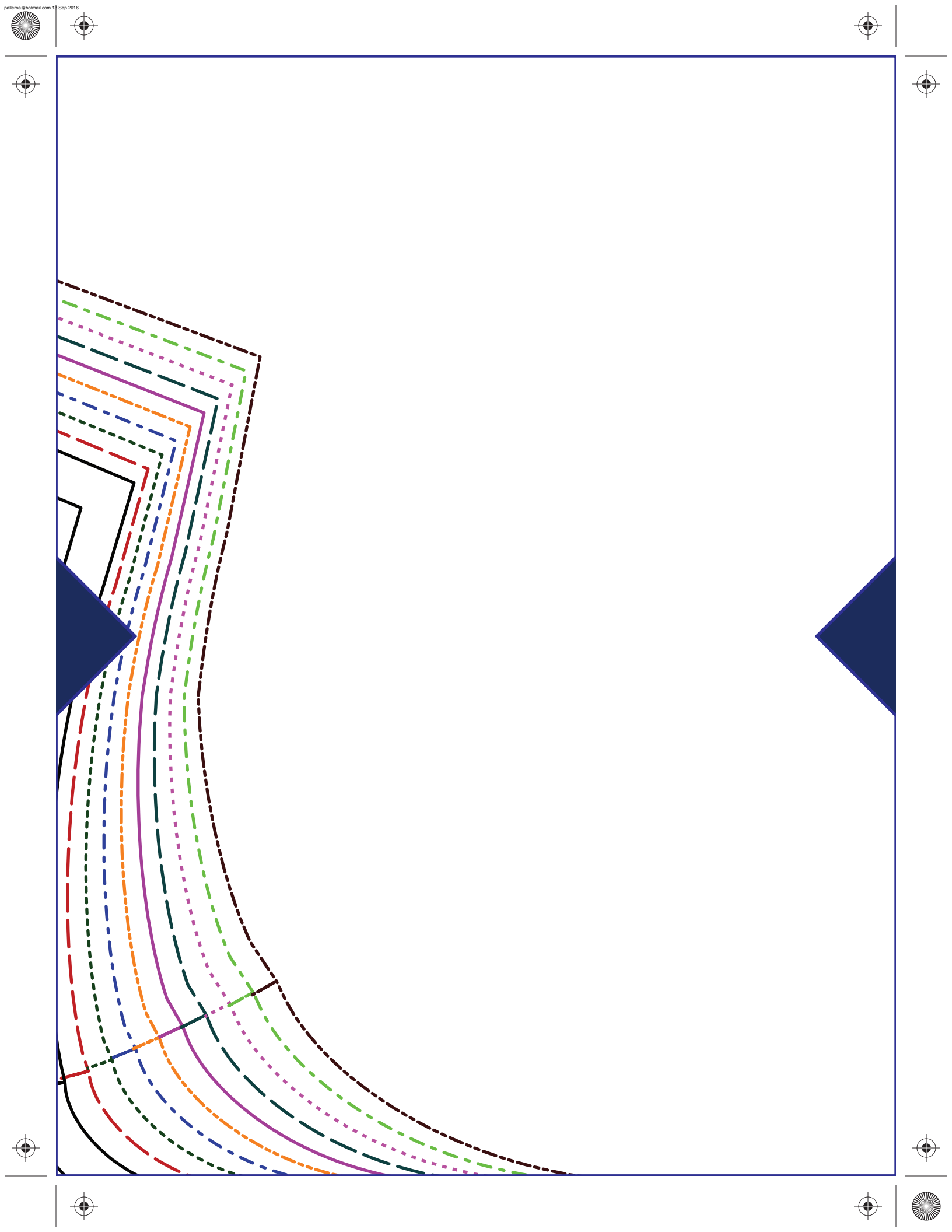

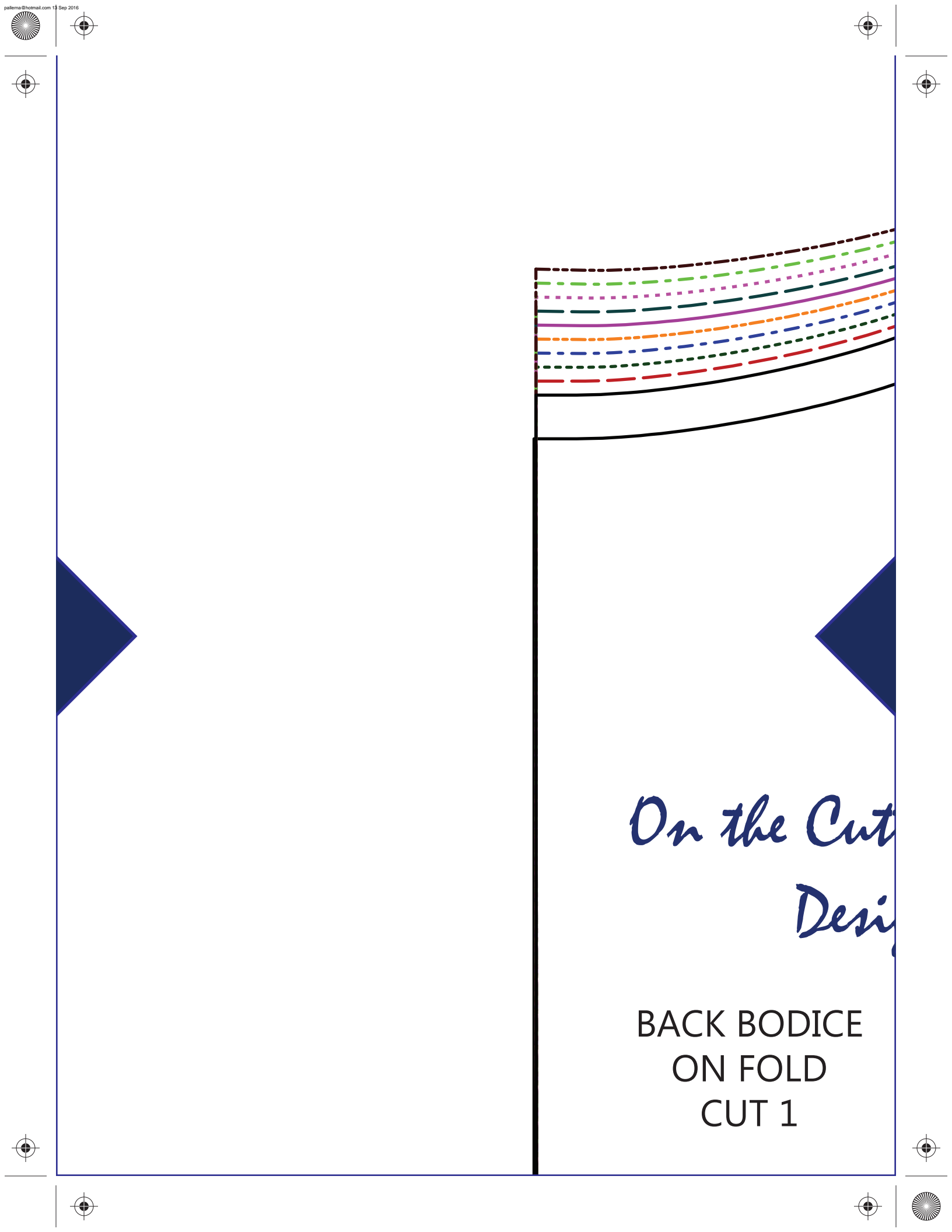

*On the Cut
Design*

BACK BODICE
ON FOLD
CUT 1

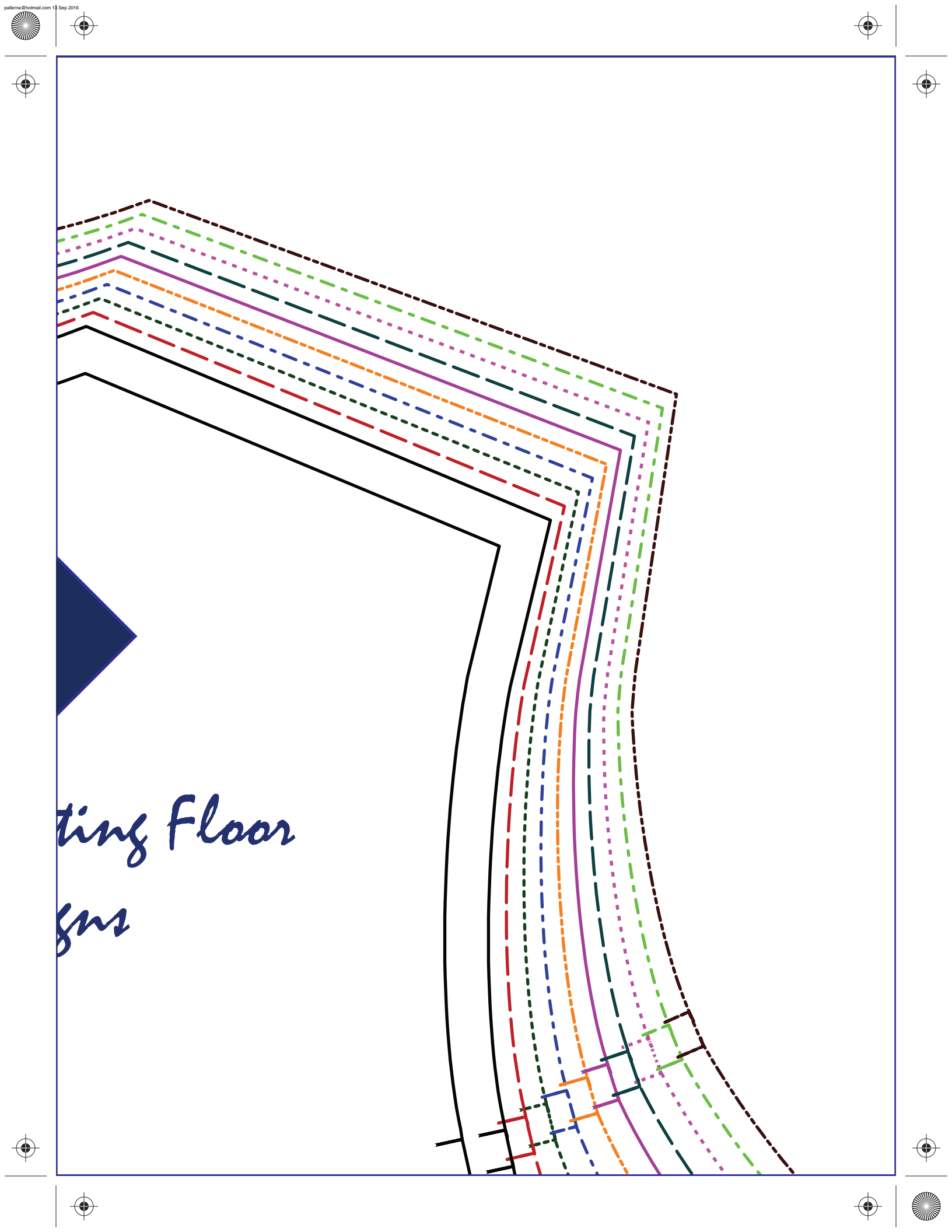

ting Floor
fms

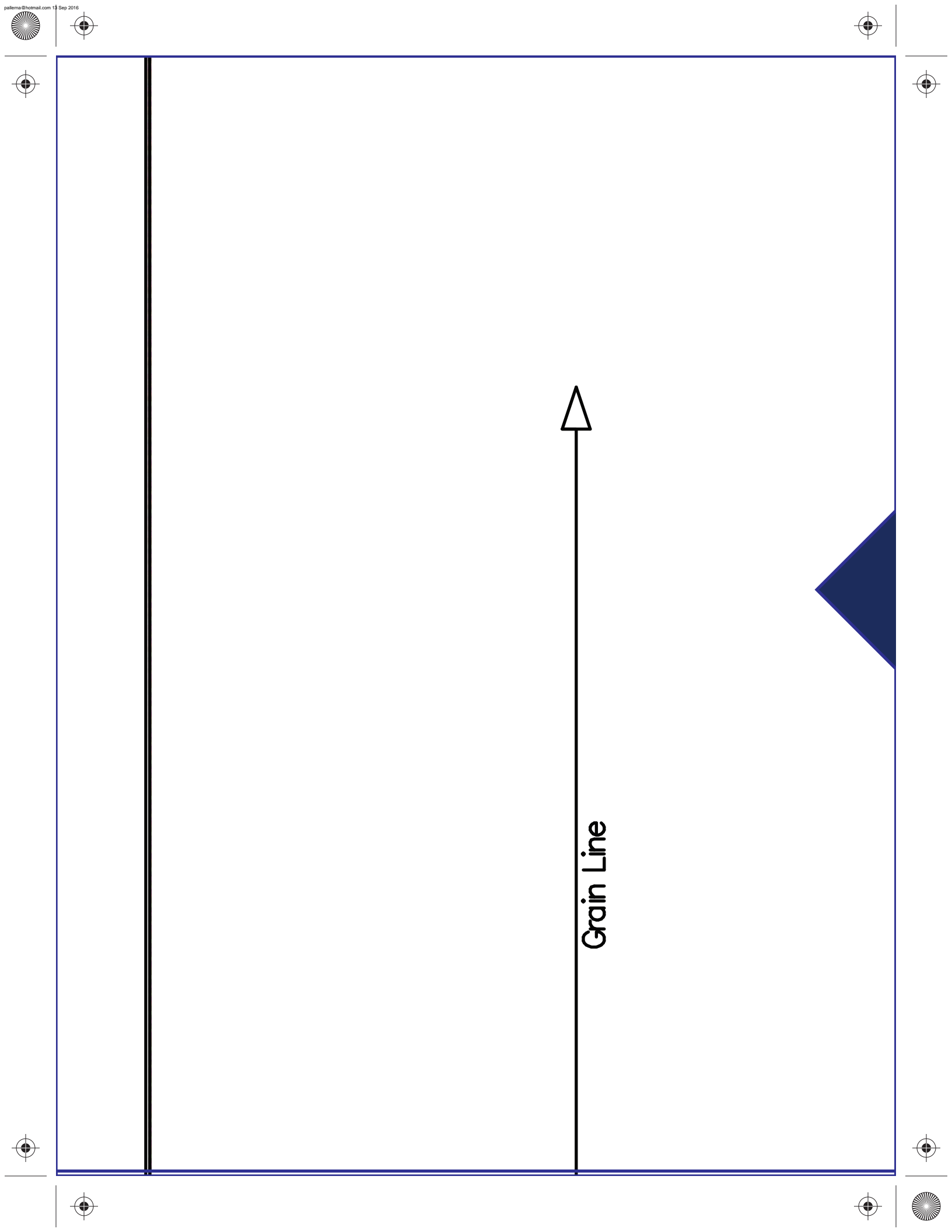

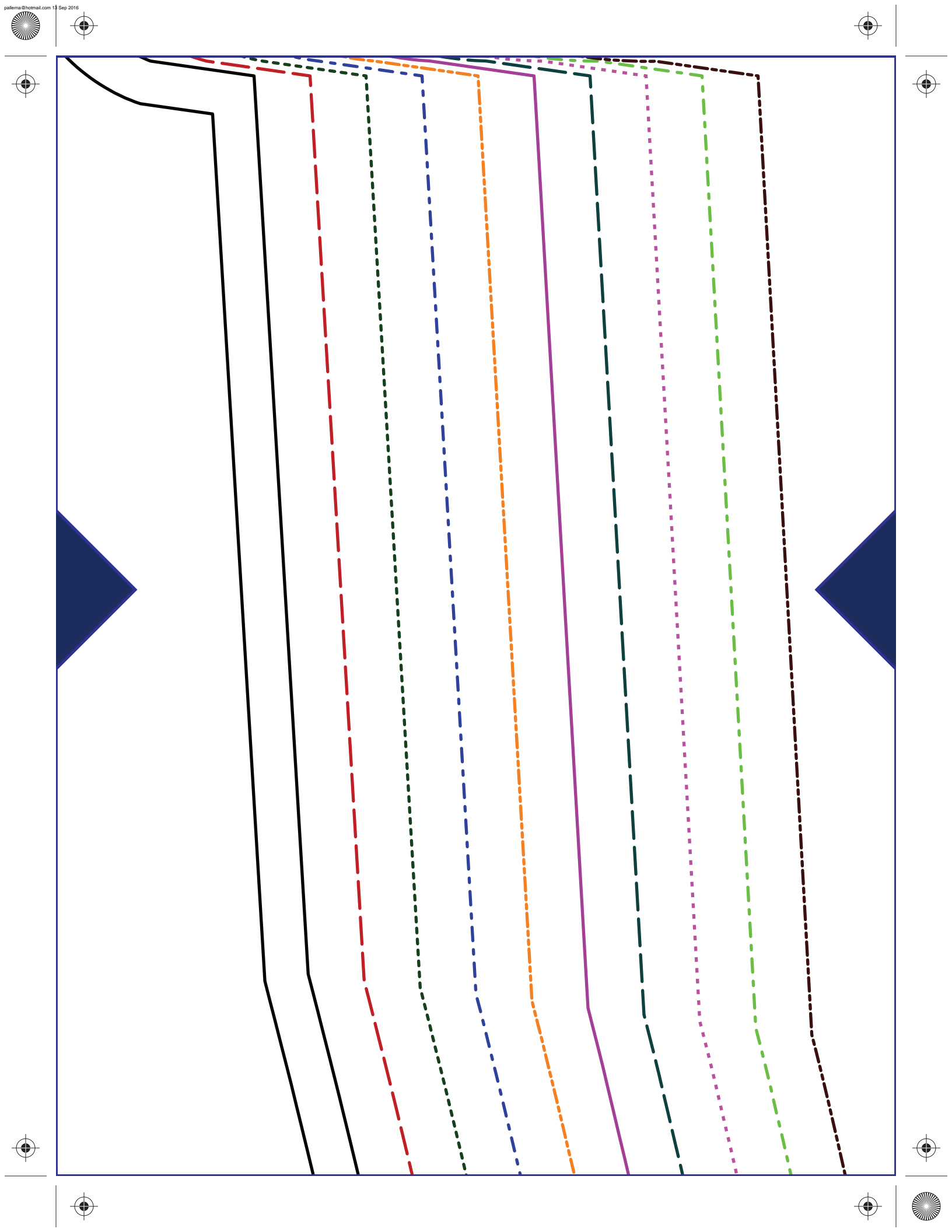

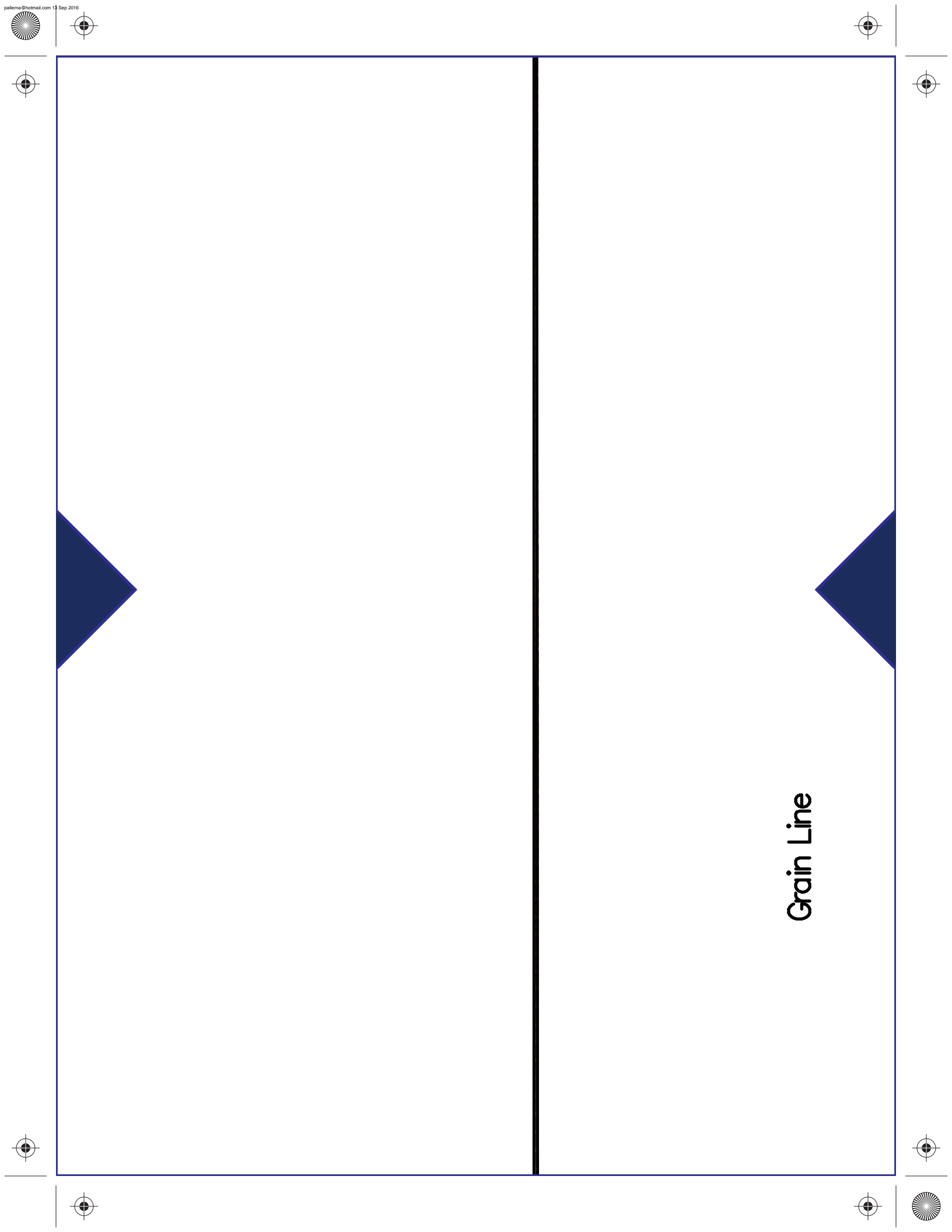

13 Sep 2016



Grain Line



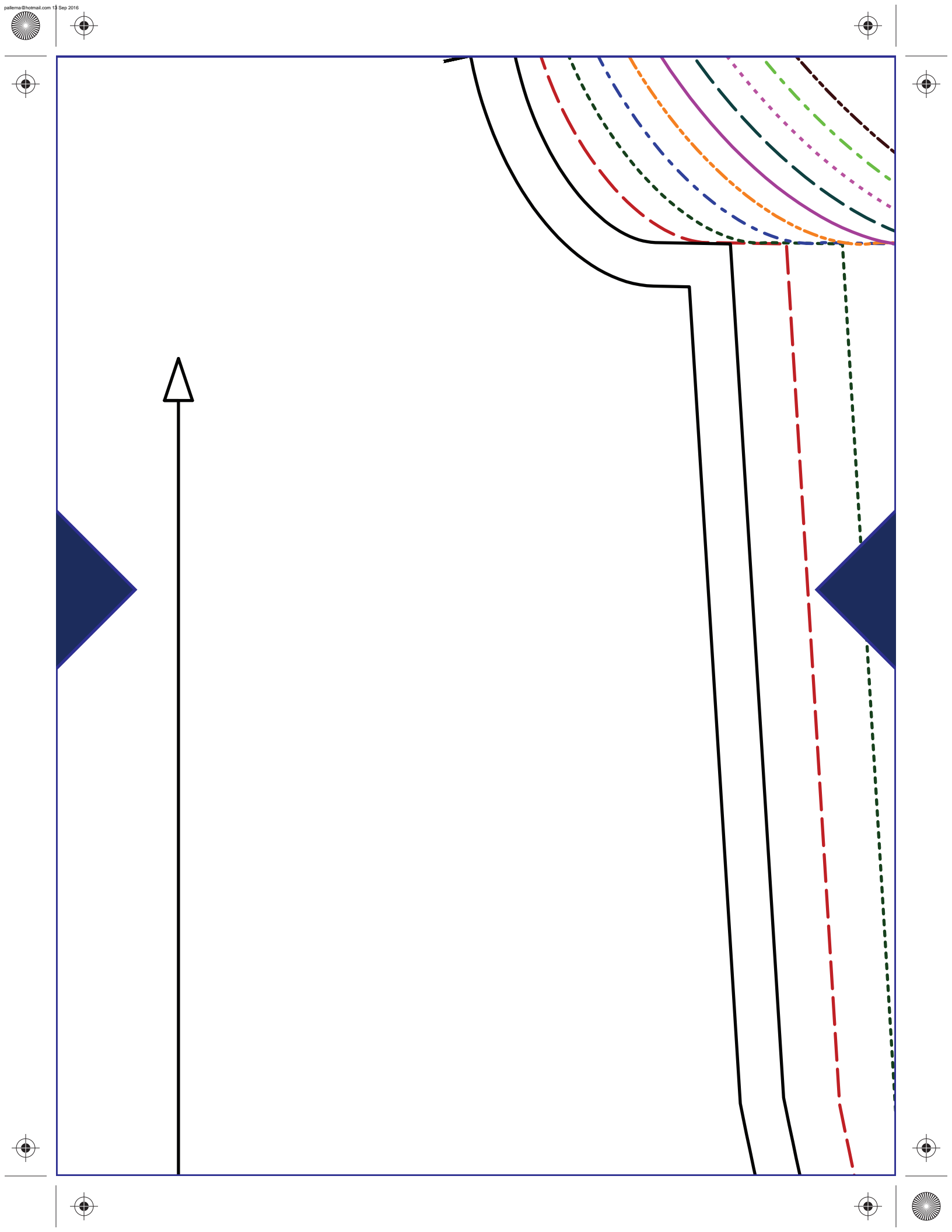

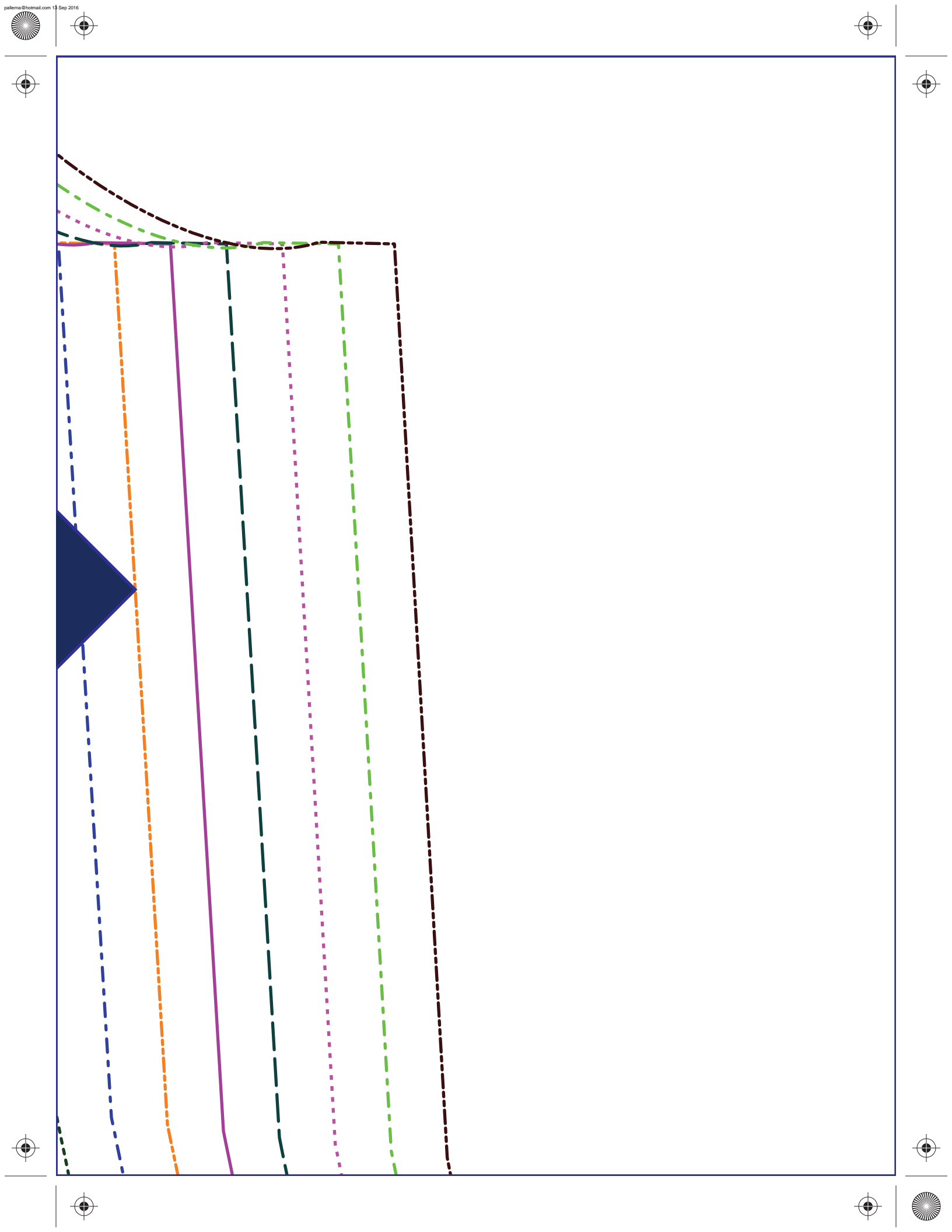

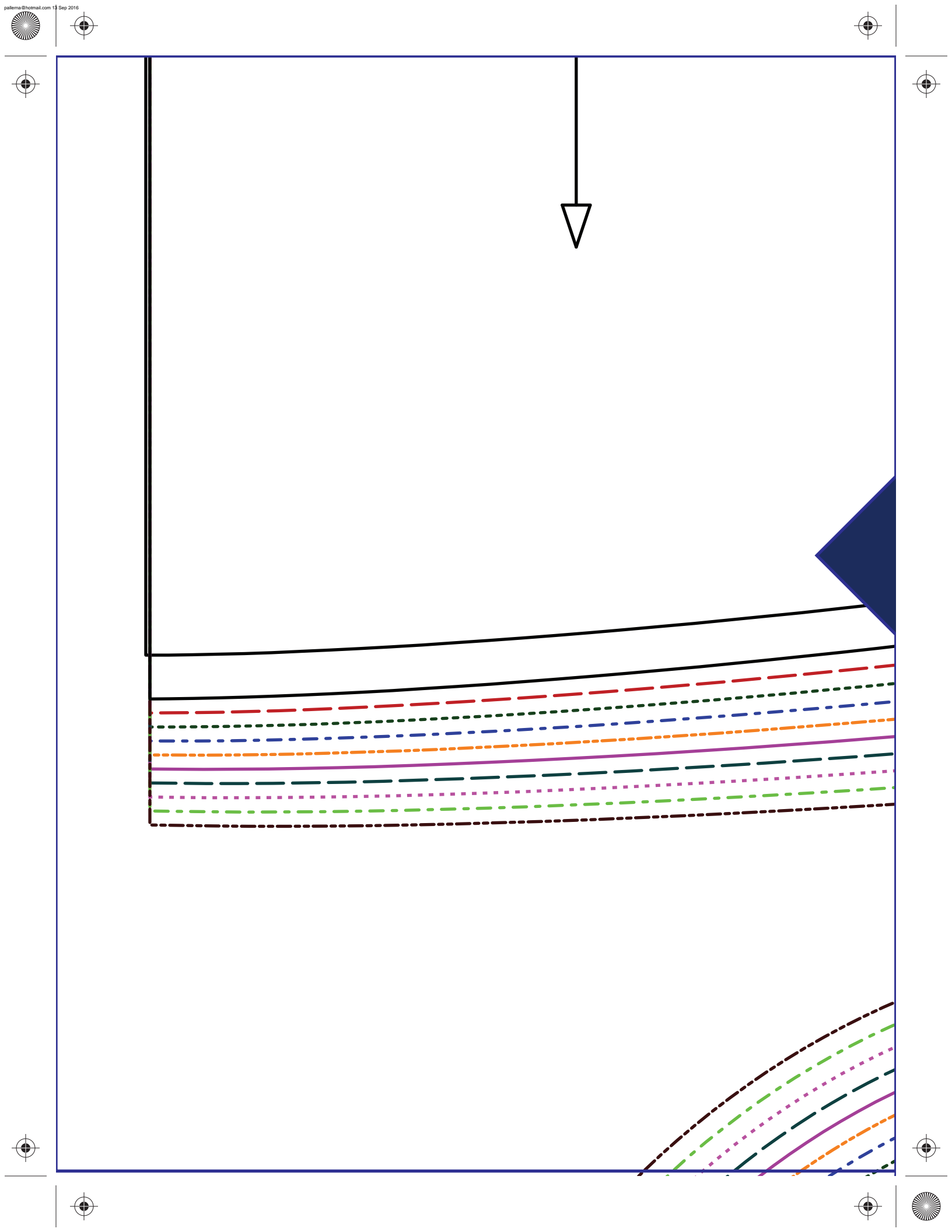

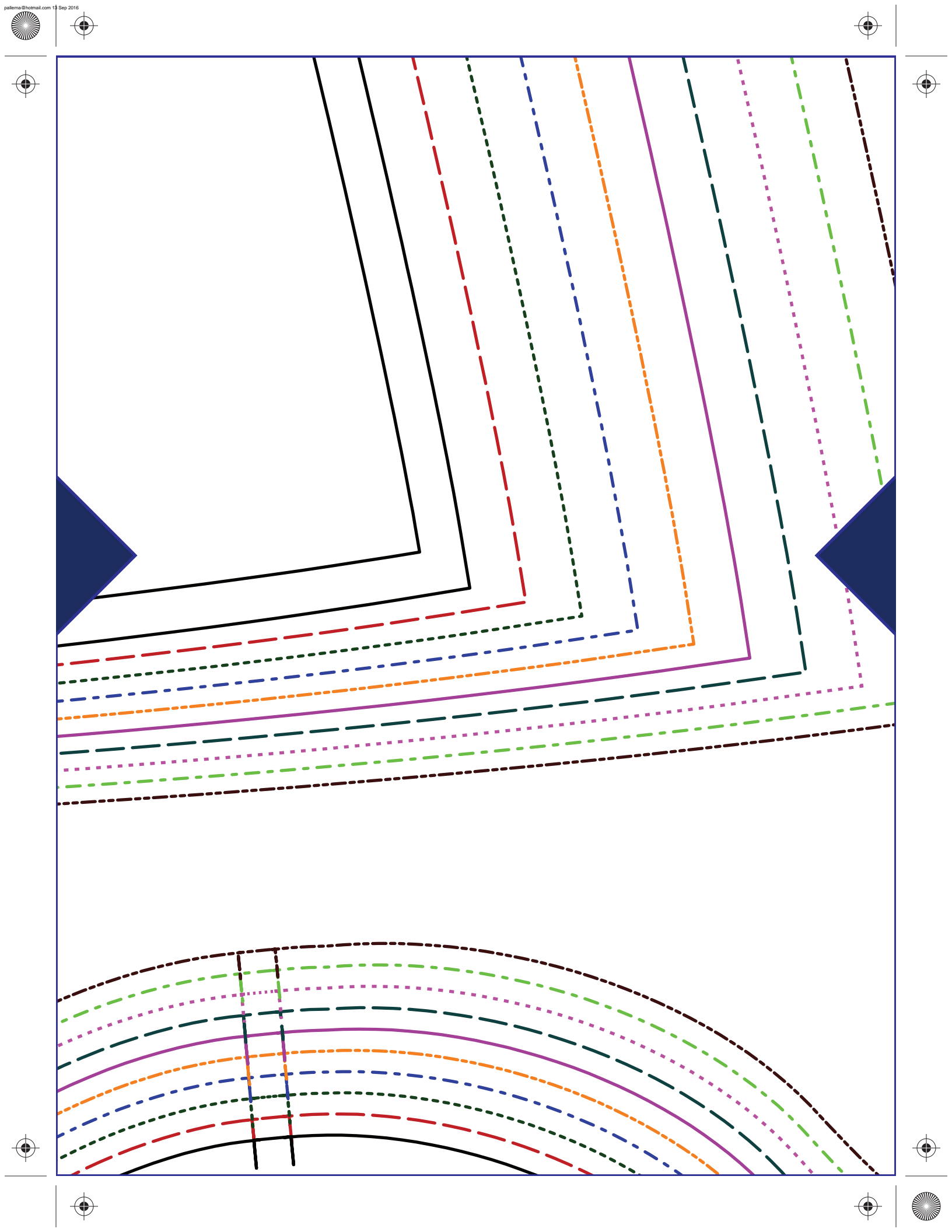

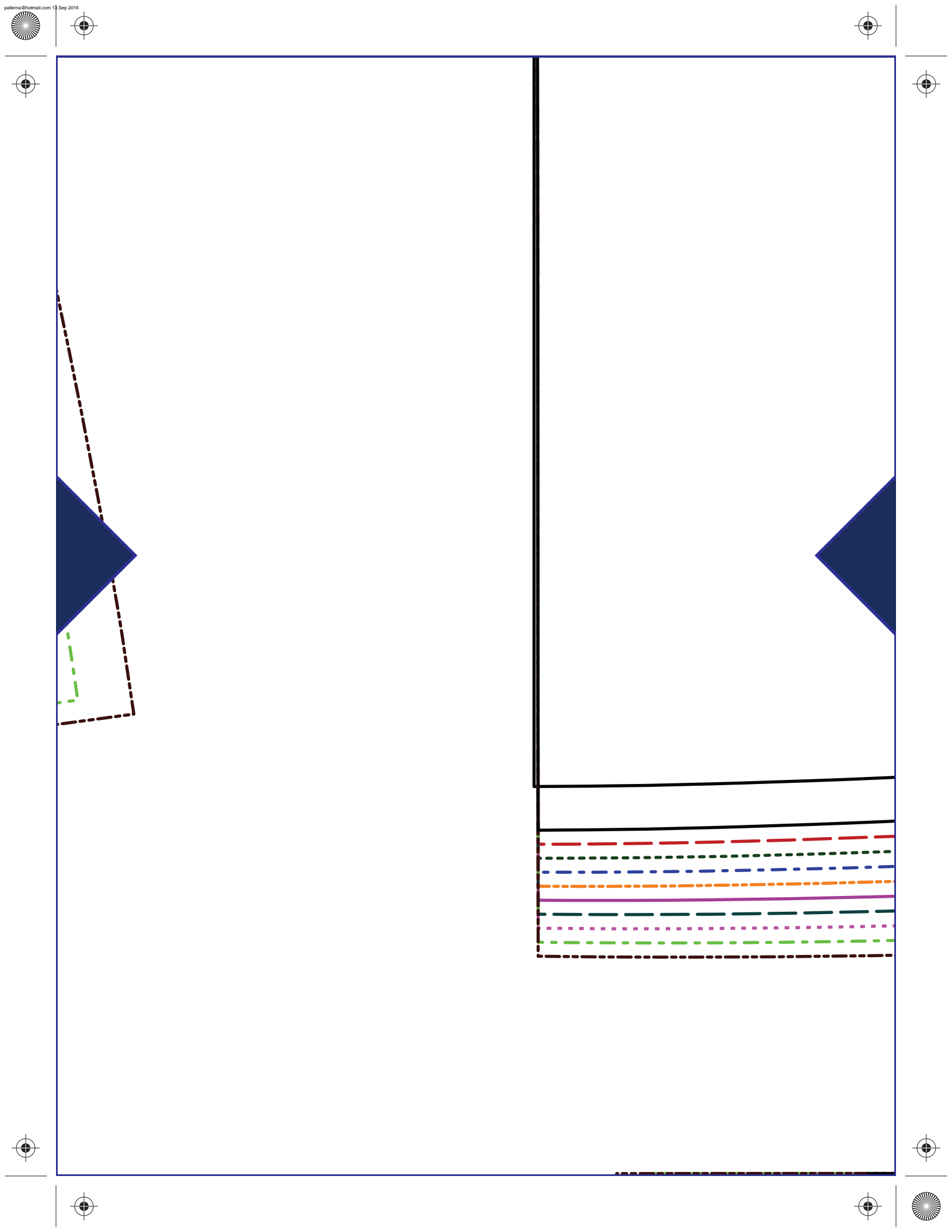

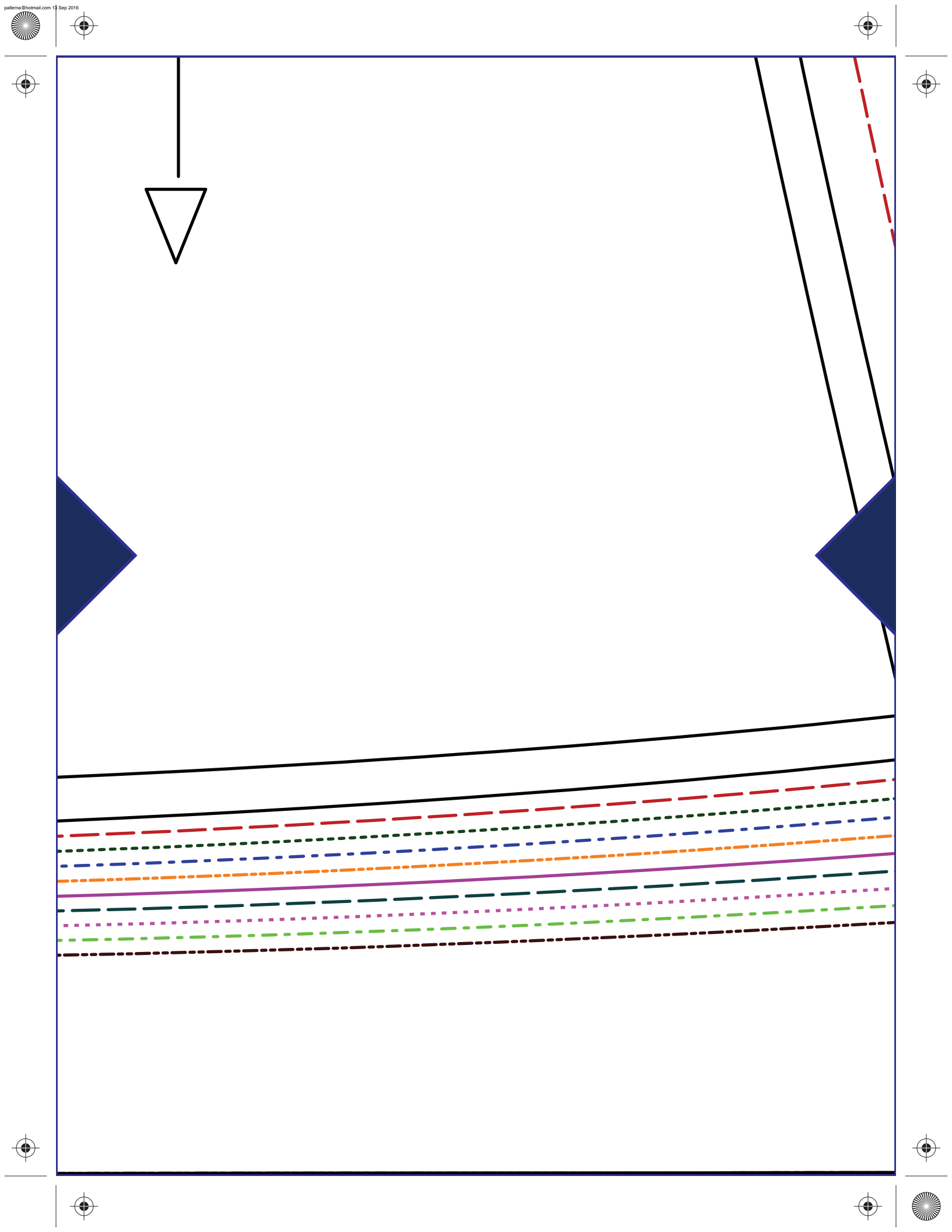

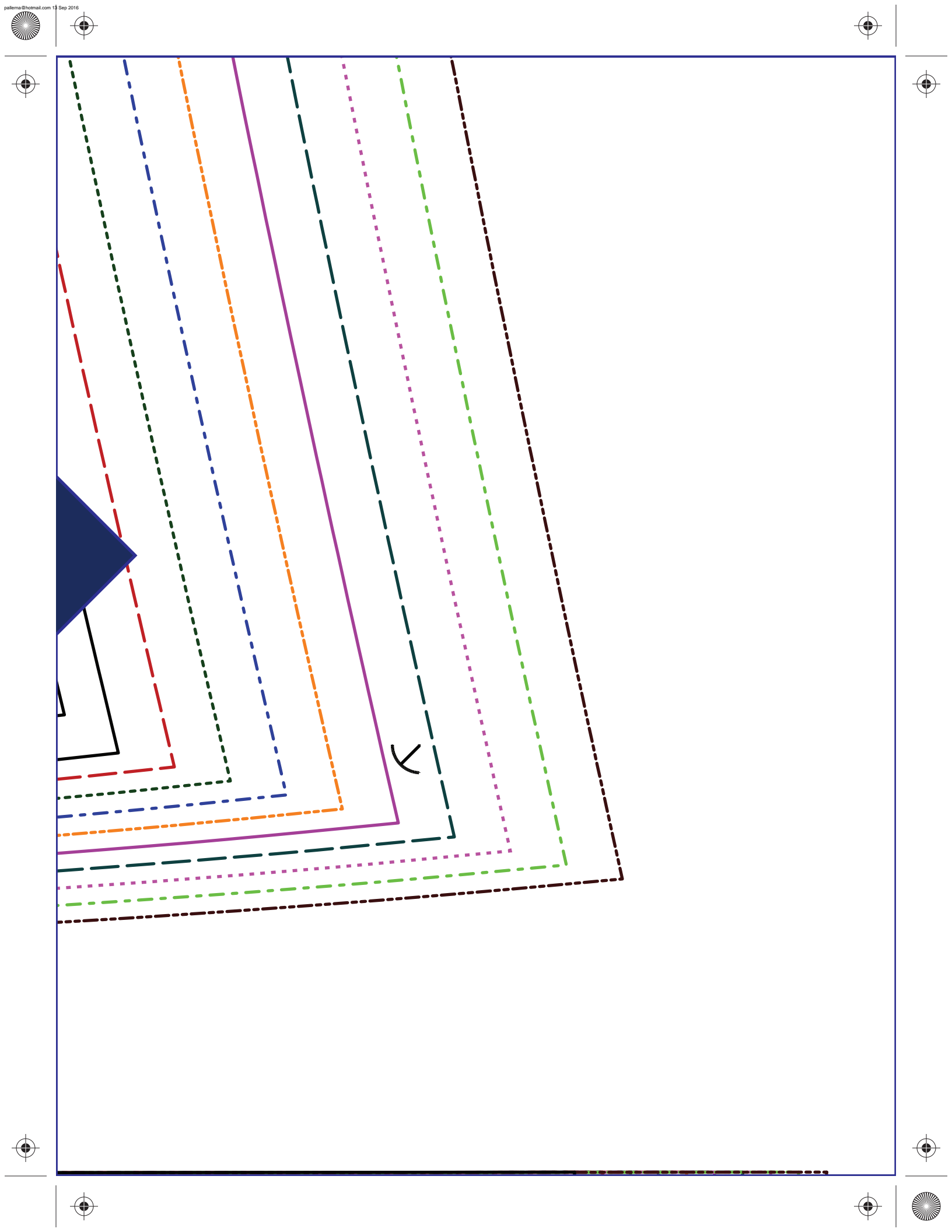

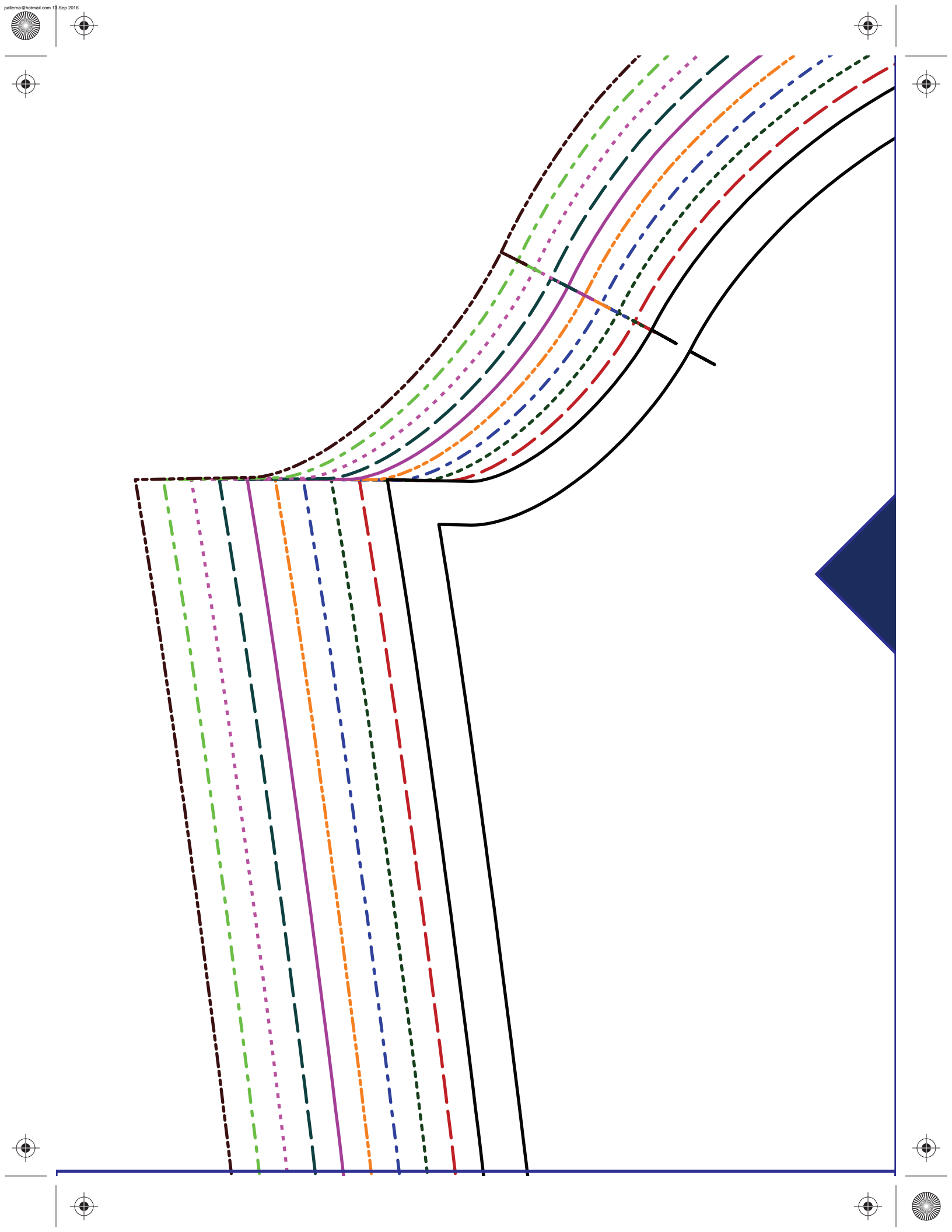

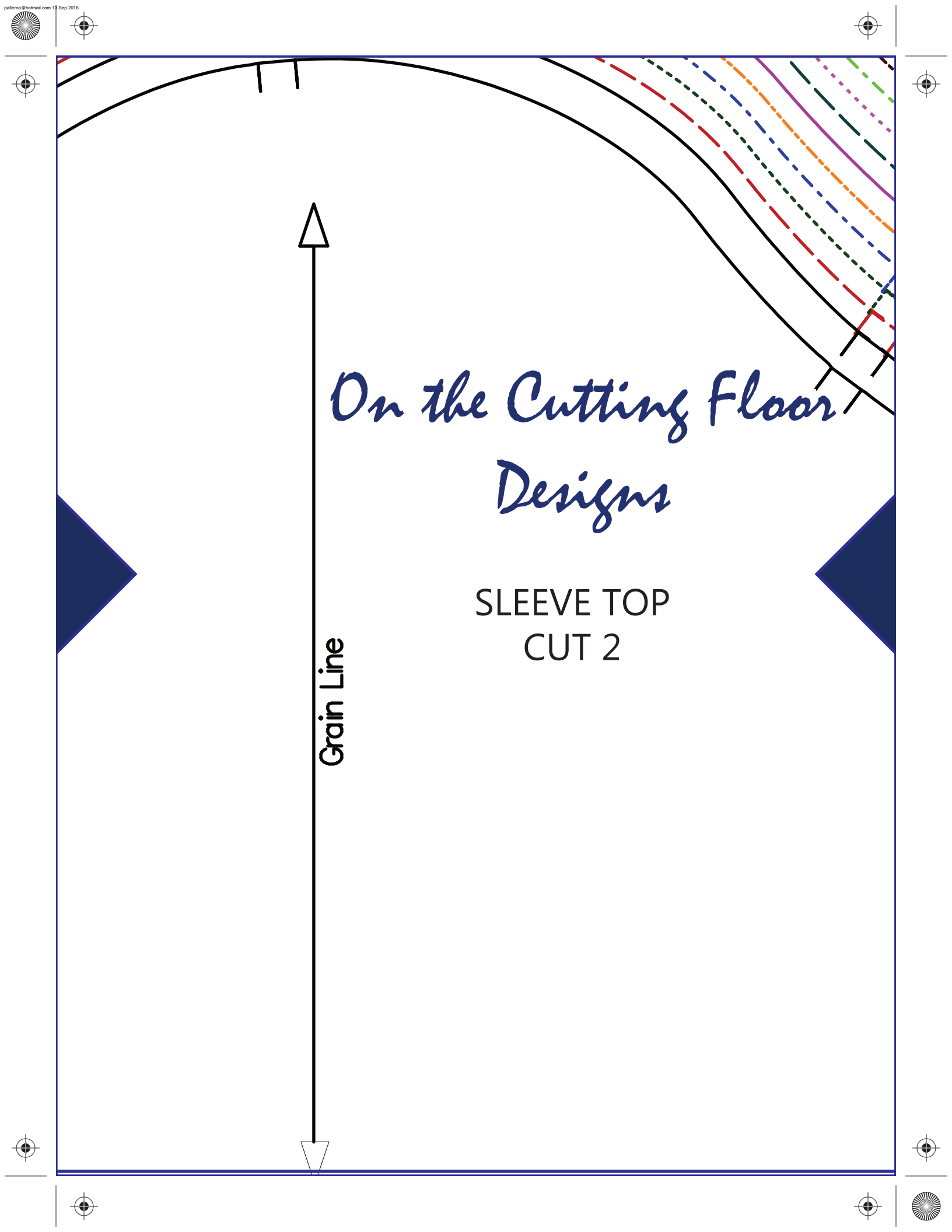

*On the Cutting Floor
Designs*

SLEEVE TOP
CUT 2

Grain Line

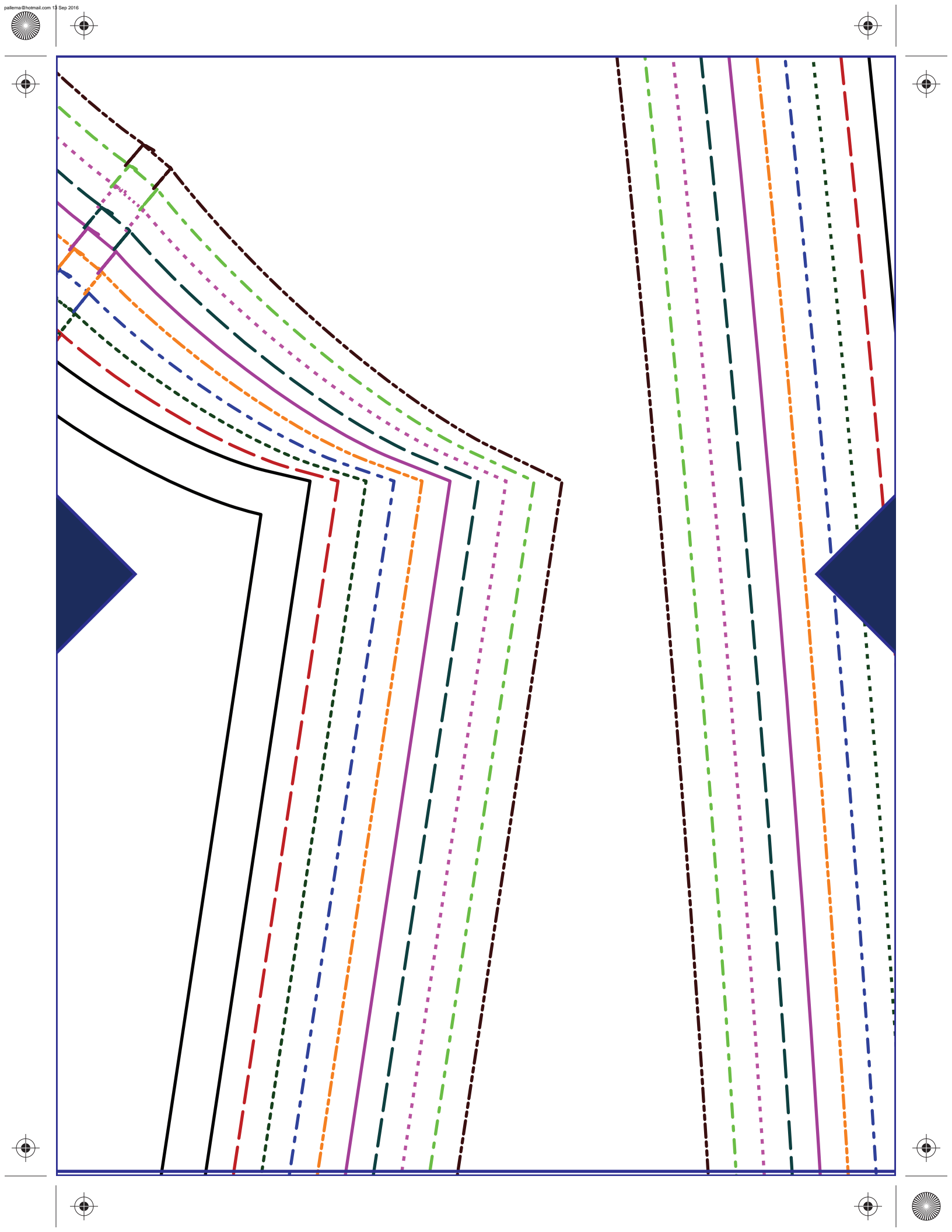

On the Cutting Floor Designs

SLEEVE BOT-
TOMSLEEVE TOP
CUT 2
CUT 2



Grain Line

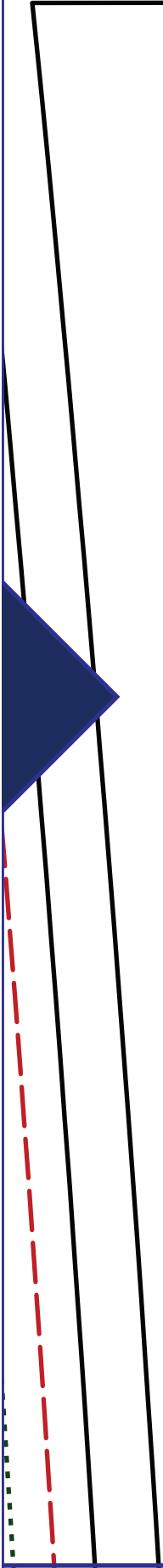

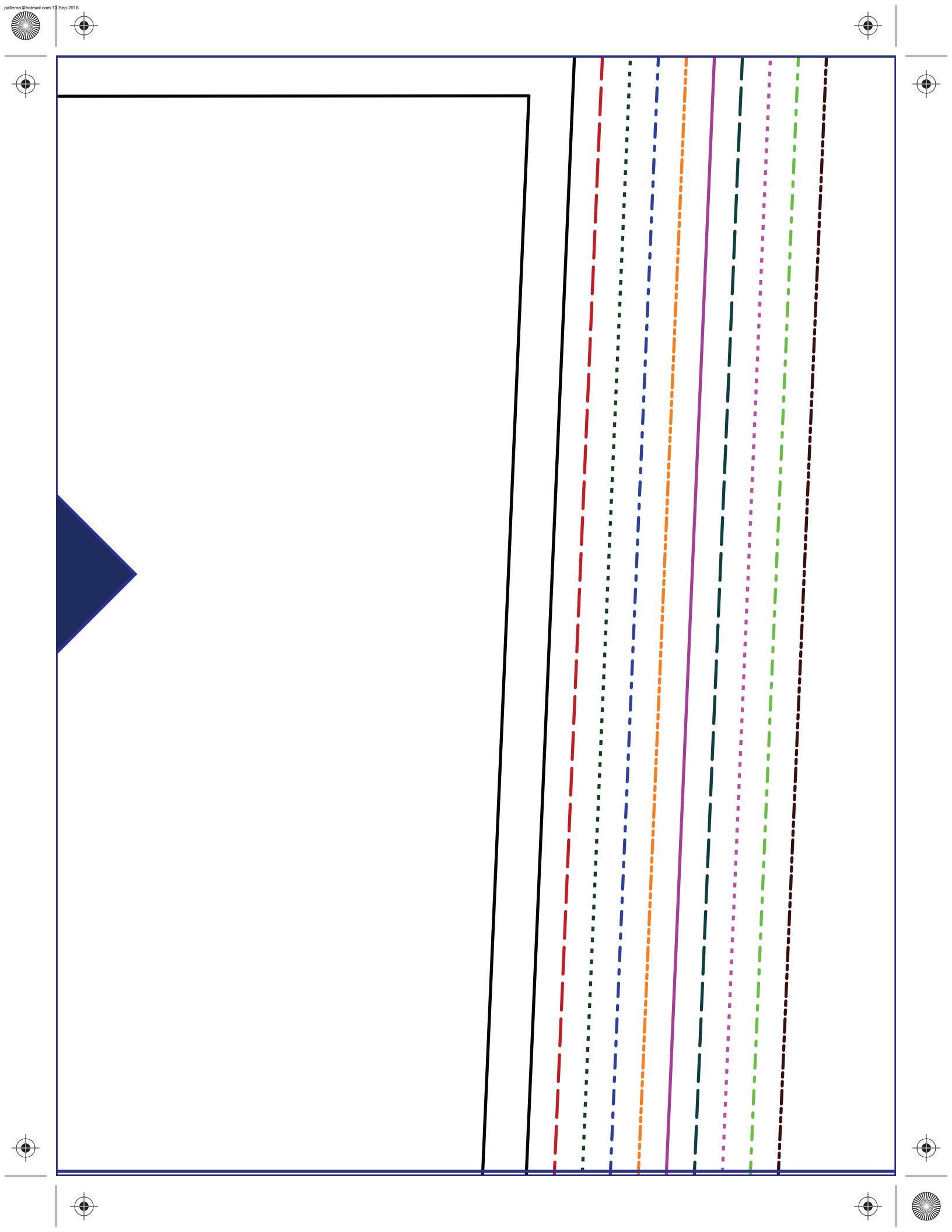

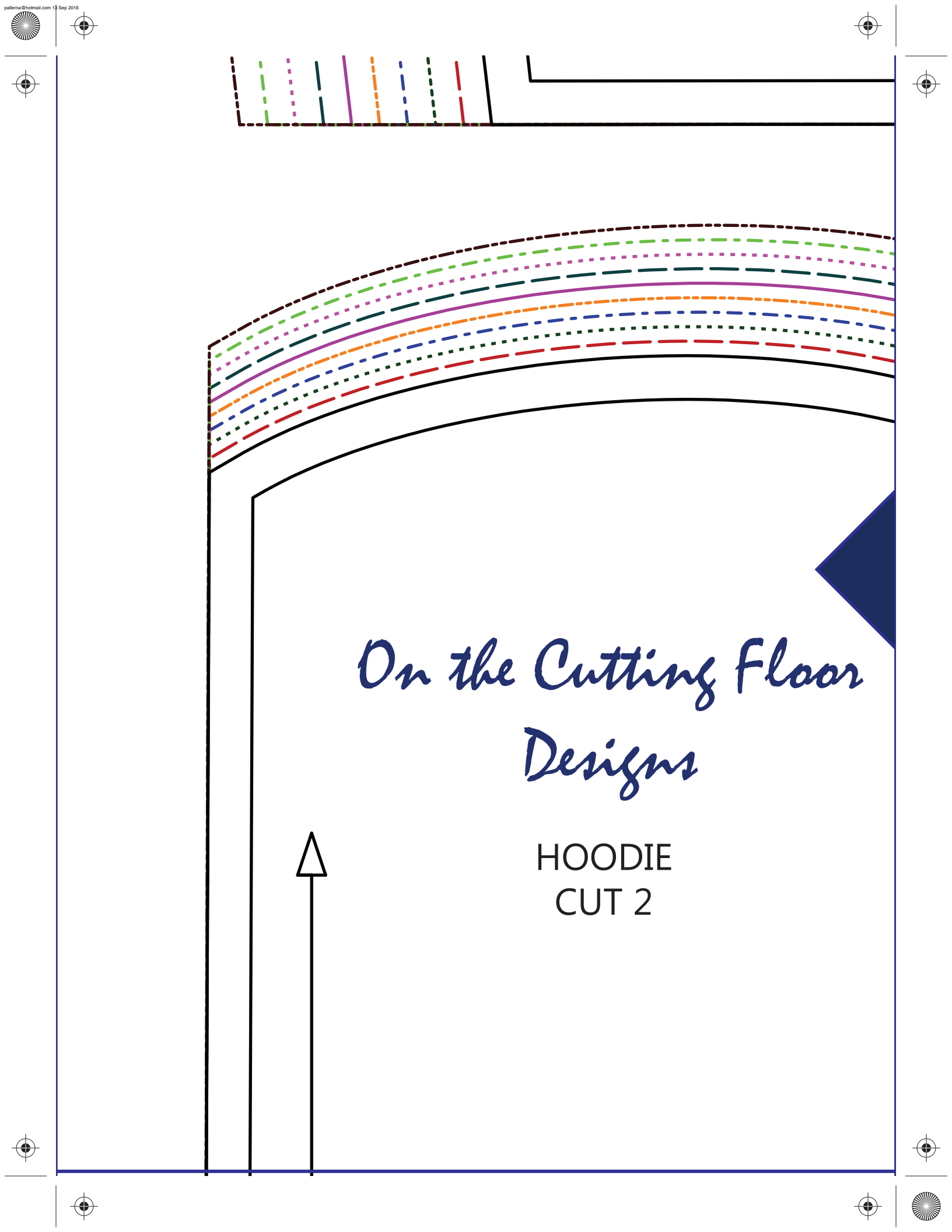

*On the Cutting Floor
Designs*

HOODIE
CUT 2



